

A Novel Architecture for Pseudo-incorporation

Yağmur Sağ, Ömer Demirok, Muhammet Bal

Received: date / Accepted: date

Abstract Pseudo-noun incorporation (PI), typically characterized by a theme NP that is adjacent to the verb and lacks case-marking, is recognized as a phenomenon distinct from noun incorporation, with unique morpho-syntactic and semantic properties that also set it apart from canonical argumentation. This paper explores a lesser-studied variant of PI involving agent arguments, which requires a surface word order that reverses the universal thematic hierarchy. This reversal raises questions about its impact on two cross-linguistic reflections of transitive syntax: accusative case and ϕ -agreement with objects. Through an empirical investigation of Turkish and Laz, we demonstrate that the case and agreement patterns in clauses with agent PI are identical to those where the agent is not incorporated. Given the view that the incorporated agent is merged lower than the theme argument (Öztürk 2005, 2009), an explanation is needed for this parallelism. To address this, we propose a general architecture that models the syntactic and semantic properties of PI. Drawing on dependent theoretic accounts of accusative case in Turkish (Baker and Vinokurova 2010) and object agreement in Laz (Bondarenko and Zompì 2023), we postulate a null ‘anchor’ pronoun in subject position in clauses with agent PI. Our analysis builds a two-layered verbal structure based on the semantics of PI proposed in Sağ (2022, 2024), where PI occurs at the level of event kinds (VP-internally) and canonical argumentation at the level of event tokens (VP-externally). Extending the anchor *pro* analysis to theme PI, we position it as a semantically contentful element within the event token domain that substitutes for the incorporated argument of the event kind. Serving as a pivotal connection between the two layers of the event domain, *pro* ensures the dependencies required for case and ϕ -agreement outputs.

Keywords (agent) pseudo-incorporation · event kinds · event tokens · two-layered argument structure · anchor *pro* · dependent case · dependent ϕ -agreement

1 Introducing the puzzle

The term *noun incorporation* describes a phenomenon attested in languages like Mohawk and Inuit, where an incorporated noun exhibits robust morpho-syntactic properties different from a canonical argumental NP that serves as an object (e.g., Sadock 1980, Mithun 1984, Baker 1988, van Geenhoven 1998). An incorporated noun forms a morphological unit with the verb, with direct consequences for its syntactic status in the clause. It cannot be separated from the verb via movement, forcing any form of modification to stay outside of the verbal complex. Furthermore, an incorporated noun does not appear to serve as an argument that is visible to the mechanism determining case assignment. Direct evidence for this can be seen in the case marking patterns. Consider a well-known contrast from Inuit:

F. Author
first address
Tel.: +123-45-678910
Fax: +123-45-678910
E-mail: fauthor@example.com

S. Author
second address

- (1) a. Angunguu-p aalisagaq neri-v-a-a
 A-ERG fish.ABS eat-IND-[+TR]-3SG
 ‘Angunguaq ate the/a particular fish.’ (van Geenhoven 1998: 13)
- b. Arnajaraq eqalut-tur-p-u-q
 A.ABS salmon-eat-IND-[-TR]-3SG
 ‘Angunguaq ate salmon.’ (van Geenhoven 1998: 15)

The canonical transitive structure in (1a) has an ergative-marked agent NP and an absolutive-marked theme NP. In the structure in (1b), what appears to carry the theme role is a noun fused into the verb while the agent NP is marked with absolutive case rather than ergative. This distinction implies that an incorporated noun is invisible to the case calculus, and hence does not serve as an argumental NP in the canonical sense. In other words, a verb incorporating its theme appears to lack an object, analogous to intransitive verbs.

Natural language has been shown to allow a similar, yet distinct, form of incorporation. This less rigid phenomenon, referred to as pseudo-incorporation (PI, henceforth) in Massam (2001), requires the incorporated noun to be adjacent to the verb, but without any apparent fusion with it. It has been argued that a pseudo-incorporated (PI’ed, henceforth) argument retains its NP-status, i.e., remains as a phrasal unit.

PI shares semantic properties with noun incorporation. Overall, a PI’ed NP obligatorily takes narrow scope with respect to other scope-taking elements, is number-neutral, and must describe a culturally salient, name-worthy eventuality along with the verb (see Mithun 1984, Bittner 1994, van Geenhoven 1998 for noun incorporation, and Farkas and De Swart 2003, Chung and Ladusaw 2004, Dayal 2011a, a.o., for PI). Additionally, PI features a cluster of morphosyntactic properties that distinguish it from canonical argumentation. For example, in Turkish, the theme NP receives accusative case when interpreted as a definite singular, as shown in (2a), but lacks an overt case marker when PI’ed, as in (2b) (Taylan 1984, Öztürk 2005).

- (2) a. Ali kitab-ı oku-du.
 Ali book-ACC read-PST
 ‘Ali read the book.’ canonical transitive
- b. Ali kitap oku-du.
 Ali book read-PST
 ‘Ali read one or more books./Ali did book-reading.’ PI

Although PI typically targets the theme argument/the direct object of a verb, some languages allow PI of agent arguments as well (e.g., see Farkas and De Swart 2003 for Hungarian). Agent PI crucially differs from theme PI in imposing a linear order that appears to reverse the universal hierarchy of thematic arguments, and thus challenges UTAH, which positions the agent argument above the theme (Baker 1988). For example, in Turkish, a PI’ed agent occurs adjacent to the verb and thus is preceded by the theme of the clause, as illustrated in (3b) (Öztürk 2005, 2009). This contrasts with the order attested in a canonical transitive construction, where the agent precedes the theme argument, as in (3a).

- (3) a. Köpek Ali-yi ısırdı.
 dog Ali-ACC bite-PST
 ‘The dog bit Ali.’ canonical transitive
- b. Ali-yi köpek ısırdı.
 Ali-ACC dog bite-PST
 ‘One or more dogs bit Ali./Ali got dog-bitten.’ agent PI

In this paper, with a primary focus on agent PI, we propose a general architecture for pseudo-noun incorporation. In the remainder of this section, we unpack the core research question of this study by examining key observations about PI, which need to be addressed within a unified framework that integrates both the semantics and the syntax of this phenomenon.

1.1 PI’ed NP is caseless

As mentioned above, under theme/object PI, the PI’ed NP is caseless. Although the only detectable surface cue of agent PI in Turkish is a word-order alternation, additional evidence suggests that this alternation is not

the sole (non-semantic) morphosyntactic reflex indicating that agent PI has occurred. Notably, there is robust evidence that a PI'ed agent in Turkish is also caseless. The difference between a canonical subject and a PI'ed one in terms of case marking is not visible in matrix clauses, as in (3b), because the nominative/unmarked case in finite matrix clauses has no overt exponence. However, the caselessness of a PI'ed agent becomes evident in nominalized embedded clauses, where a canonical subject is necessarily marked with the genitive case, while a PI'ed subject remains caseless, as illustrated below (Johanson 1977, Kornfilt 1984, 1997, von Heusinger and Kornfilt 2005, Öztürk 2005, Sağ 2019, 2022).

- (4) a. [Köpeğ*(-in) Ali-yi ısırdı-ğın-ı] bil-iyor-um.
 dog-GEN Ali-ACC bite-NMLZ-3SPOSS-ACC know-IMPRF-1SG
 'I know that the dog bit Ali.' canonical transitive
- b. [Ali-yi köpek(-in) ısırdı-ğın-ı] bil-iyor-um.
 Ali-ACC dog-GEN bite-NMLZ-3SPOSS-ACC know-IMPRF-1SG
 Without GEN: 'I know that Ali got dog-bitten.' agent PI
 With GEN: 'I know that the dog bit Ali.' canonical transitive

Further support that PI'ed agents are caseless comes from the Pazar (Atina) dialect of Laz (Öztürk and Pöchtrager 2011), which differs from Turkish in exhibiting surface active-ergative case alignment (in the sense of Woolford (2015)). In Laz, agents are marked with ergative case. However, agent PI not only reverses the canonical agent-theme word order but also suppresses the case marking on the agent, as demonstrated in the following contrast:¹

- (5) a. Laç'i-k bere-s goyo-k'ap'-u.
 dog-ERG child-DAT over-attack-PST.3SG
 'The dog attacked the child.' canonical agent serving as the subject
- b. Bere-s laç'i goyo-k'ap'-u.
 child-DAT dog over-attack-PST.3SG
 'One or more dogs attacked the child./The child got dog-bitten.' PI'ed agent
- c. *Laç'i bere-s goyo-k'ap'-u.
 dog child-DAT over-attack-PST.3SG

1.2 Agent PI and UTAH

A particularly pressing question concerning agent PI arises from the fact that the agent NP appears to be structurally closer to the verb, i.e., lower than the theme NP, in the syntactic output. Is this apparent reversal the result of a derivation involving the object NP moving over the PI'ed agent, or does it reflect an underlying order where the PI'ed agent is merged before the object is introduced into the derivation?

In this paper, we adopt the view that the PI'ed agent is merged before the theme NP, following Öztürk (2005, 2009). This approach is preferable for several reasons. While we will delve into the specifics later, movement-based analyses lack a clear motivation for object fronting beyond generating the intended word order that establishes the adjacency between the PI'ed agent and the verb.² More importantly, as we will demonstrate, movement-based analyses not only raise issues concerning the semantics of PI but also predict unattested case patterns.

Conversely, assuming that agent PI involves merging the PI'ed argument before the theme NP raises the obvious question: How do we reconcile this with UTAH, which requires that theme NPs be merged before agent NPs? Addressing this apparent reversal is one of the key goals of this paper.

¹ The third author of this paper is a native speaker of Laz besides being a well-trained linguist. The variety of Laz he speaks, from which the data reported here comes from, is spoken in Pazar. More comprehensive fieldwork is needed to see to what extent pseudo-incorporation is attested across different Laz varieties.

² See Dikmen et al (2023) for an analysis of this type where the object movement is stipulated via a formal feature that happens to be obligatory in agent-PI structures.

1.3 PI and Case/Agreement Calculus

Given that PI'ed NPs are caseless, one might expect PI to influence the case and agreement outputs of other NPs in the clause. However, it appears that PI has no such effect. We have already seen this for agent PI above. As shown in (3b), the theme NP still receives accusative case when the agent undergoes PI in Turkish.

Now, let us illustrate this point for theme PI. In causative constructions in Turkish (Taylan 1984), when an intransitive verb is causativized, the causee receives accusative, as shown in (6a). However, when a transitive verb is causativized, the causee is marked dative, as demonstrated in (6b). And finally, when a transitive verb with a PI'ed object is causativized, the causee still receives dative case even though the theme argument is not accusative-marked, as illustrated in (6c). If the PI'ed object were invisible to the case calculation mechanism, we would presumably expect the causee to be accusative, as in (6a).

- (6) a. Sevgi Ali-**yi** koş-tur-du.
 Sevgi Ali-ACC run-CAUS-PST
 'Sevgi made Ali run.' causativized intransitive
- b. Sevgi Ali-**ye** kitab-ı oku-t-tu.
 Sevgi Ali-DAT book-ACC read-CAUS-PST
 'Sevgi made Ali read the book.' causativized transitive
- c. Sevgi Ali-**ye**/*-**yi** kitap oku-t-tu.
 Sevgi Ali-DAT/*ACC book read-CAUS-PST
 'Sevgi made Ali do book-reading.' causativized construction with PI

For clauses with agent PI, we have taken the linear order to mirror the structural hierarchy of the thematic arguments. Under this view, the fact that the theme NP is marked accusative when the agent is PI'ed poses a challenge to theories where accusative case assignment is dependent on the presence of a c-commanding NP, such as the Dependent Case Theory (e.g., Baker and Vinokurova 2010, Baker 2015).

- (7) Dependent Case Assignment (Baker and Vinokurova 2010: 595)
 If there are two distinct NPs in the same spell-out domain such that NP1 c-commands NP2, then value the case feature of NP2 as *accusative* unless NP1 has already been marked for case.

Assuming that the Dependent Case Theory is on the right track, we predict that the theme argument is c-commanded by another NP at some point in the derivation so that it is assigned accusative case.

A parallel observation comes from ϕ -agreement patterns in Laz. Laz exhibits prefixal person agreement, which prioritizes *m-set* markers for participant objects, otherwise, hosts *v-set* markers for subjects (with *b-*, *p-*, *p'*- allomorphs agreeing in voicing with consonant-initial stems). Crucially, incorporating the agent does *not* eliminate canonical object agreement with the theme NP, as shown in (8a), contrasting with single argument verbs, i.e., unaccusatives and unergatives, which exclusively exhibit subject agreement, as seen in (8c). If PI were to render the agent invisible to the agreement mechanism, we would expect *v-set*/subject agreement to emerge, akin to what occurs with single-argument verbs.

- (8) a. Ham oruba-s ma mtuti **m'**-ç'op-um-s.
 this river-LOC 1.SG bear 1.OBJ-catch-IMPf-PRS.3SG
 'In this river, I'd get *bear*-caught.' agent PI
- b. **b**-ğurur, ***m**-ğurur
 1.SBJ-die.IMPf, 1.OBJ-die.IMPf
 'I am dying.' unaccusative
- c. **v**-inçir, ***m**-inçir
 1.SBJ-swim.IMPf, 1.OBJ-swim.IMPf
 'I am swimming.' unergative

The prefixal ϕ -agreement pattern in Laz has recently been analyzed within a dependent-theoretic framework of agreement in Bondarenko and Zompì (2023). In simplified terms, agreement with participant objects is *dependent* on the presence of two distinct NPs accessible to the probe (the *v* head), which is low in the structure and searches for a goal within its complement first and then its specifier via Cyclic Agree (Béjar and Rezac 2009). If the probe successfully copies features from two distinct NPs, we observe *dependent*

agreement (*m-set* markers) realizing the features of the first target of the probe (i.e., the theme NP). In cases where the probe cannot find two NPs, it results in *unmarked agreement* (*v-set* markers).

This view, which shares similar insights with the dependent-theoretic account of the accusative case, raises questions similar to those arising from the preservation of accusative marking in clauses involving agent PI in Turkish. In other words, the availability of *m-set* agreement markers for the theme argument indicates that the probe finds a second NP in its specifier when the agent is PI'ed. The puzzle is what this NP is if the agent is incorporated below the theme.

1.4 Interim Summary and Road Ahead

We have outlined three broad empirical claims about PI, which we will revisit in the main discussion.

- (9)
- a. Claim-1: PI'ed NPs are caseless.
 - b. Claim-2: The PI'ed agent is merged lower than the theme.
 - c. Claim-3: PI does not alter case and agreement outputs of other NPs in the structure.

The greatest tension lies in the consequences of Claim-2.

1. How do we reconcile Claim-2 with UTAH? How is that a PI'ed agent is merged lower than the object/theme NP?
2. How does the accusative case on the theme NP surface in Turkish, and how does object agreement persist in Laz when the agent NP undergoes PI in these languages?

Our ultimate objective is to establish a comprehensive understanding of these empirical claims within a unified architecture of PI. Adopting a model wherein incorporated arguments are introduced lower inside the VP, we offer a straightforward analysis that sustains a transitive argument structure, which still satisfies the requirement of dependent case assignment in Turkish as well as ensuring object agreement with the theme argument in Laz. We argue that a null pronoun (*pro*) occupies the canonical position of an agent argument (spec, *vP*) as a placeholder and an anchor when the agent is PI'ed internally within the VP.³

The motivation behind our analysis is driven by the semantics of PI proposed in Sağ (2024), which posits this phenomenon as an event-kind level argumentation process. Under this view, a verb that denotes at the level of event kinds takes a singular/taxonomic kind argument (in the sense of Dayal 2004) to yield a sub-kind of an event kind (cf. Sağ 2019, 2022). This deep-level argumentation happens VP-internally. Canonical argumentation, on the other hand, happens only after event kinds type-shift to event tokens, which occurs above the VP, suggesting a two-layered alignment in argument structure. We maintain that UTAH operates within the event token domain independently of the argumentation in the event kind domain, implying that the reversed thematic order in agent PI does not violate this principle.⁴ Furthermore, in extending our analysis to include PI of theme arguments, we propose that the merge of the null 'anchor' *pro* is motivated on semantic grounds: its function is to forge a relation between the singular kind introduced as a thematic argument at the event kind domain and the object-level members of that kind, which maintain the corresponding thematic relation at the event token domain.

The outline of this paper is as follows: In Section 2, we begin by discussing the syntactic and semantic characteristics of PI in Turkish and Laz. Section 3 outlines the semantic analysis of PI adopted in this study, delving into its implications for adverbial modification and UTAH. In Section 4, we discuss how accusative case assignment in Turkish and object ϕ -agreement in Laz pose challenges to be addressed in our system. Section 5 presents our core analysis. Section 6 provides additional support for our analysis through the examination of passivization in Turkish and Laz, as well as oblique subject constructions in Laz. Section 7 extends the analysis to clauses with theme PI and reevaluates dative case assignment in Turkish from a dependent-theoretic perspective. Section 8 concludes the paper.

³ We later refer to this null pronoun as *b-pro* (in Section 5), where we motivate this label in connection with its anchoring role.

⁴ This claim is presented in a broad sense, as interpretations of the universal hierarchy of thematic arguments vary in the literature, ranging from absolute to relativized perspectives. A thorough discussion of UTAH in relation to agent PI will be provided in Section 3.2.2.

2 Pseudo-incorporation in Turkish and Laz

Turkish is one of the languages recognized in the literature for featuring PI. Öztürk (2005) shows that Turkish exhibits PI for both theme and agent arguments. In this section, we will begin by reviewing the syntactic and semantic characteristics of this phenomenon, drawing from previous literature on Turkish PI. Afterwards, we will demonstrate that Laz is another language that allows PI of both theme and agent arguments.

2.1 Pseudo-incorporation in Turkish

Non-case-marked nouns occupying the direct object position, as shown in (10b), are analyzed as PI'ed arguments in Turkish. One notable requirement of PI is adjacency between the PI'ed noun and the verb. For instance, an adverb cannot intervene between the two, while this is possible with accusative case-marked direct objects:

- (10) a. Ali [hızlıca] kitab-ı [hızlıca] oku-du.
 Ali quickly book-ACC quickly read-PST
 'Ali read the book quickly.'
 b. Ali [hızlıca] kitap [*hızlıca] oku-du.
 Ali quickly book quickly read-PST
 'Ali read one or more books fast./Ali did book-reading fast.'

In Baker (1988), noun incorporation is argued to involve a movement process where the noun head moves from its base position inside the direct object phrase and adjoins to the verb head, resulting in a strict adjacency relation between the two elements of incorporation. The data in (10) at first sight suggests that Baker's head incorporation analysis can also be maintained for Turkish non-case-marked direct objects. However, Taylan (1984) and Öztürk (2005) argue against this view (cf. Baker 2014b). Taylan shows that focus particles like the additive *da* 'also', the scalar particle *bile* 'even', and the question particle *mi* can cliticize on the PI'ed noun, implying that the verb and the noun do not form a single morphological unit:

- (11) Ali kitap da oku-du.
 Ali book also read-PST
 'Ali also did book_F-reading.'

Furthermore, it has been observed in Sezer (1996), Öztürk (2009), and Gračanin-Yüksek and İşsever (2011) that incorporated arguments can be separated from the verb through scrambling for information structural reasons. In other words, while the adjacency contrast, as exemplified in (10), holds in the unmarked word order (i.e., the broad focus configuration, where the Question Under Discussion (QUD) is 'what happened'), topicalizing or focusing any phrase in the sentence may result in the dislocation of the incorporated argument from its base-position. Consider (12), for instance, which is felicitous in a context where the subject is contrastively focused in the preverbal position.

- (12) Kitap, Ali_F oku-du, Ece değil.
 book Ali read-PST Ece not
 'It was Ali who did book-reading, not Ece.'

Öztürk (2005) provides evidence against a head incorporation analysis based on ellipsis and coordination. First, it is possible to elide the incorporating verb, as illustrated in (13), and second, it is possible to coordinate the incorporated noun or the verb, as seen in (14) (Öztürk 2005: 39). These facts show that the incorporated argument cannot be considered a head forming a morphological complex with the verb.

- (13) Ali kitap oku-du, dergi değil.
 Ali book read-PST magazine not
 'Ali did book-reading, not magazine (reading).'
- (14) a. Ali [kitap ve dergi] oku-du.
 Ali book and magazine read-PST
 'Ali did book-reading and magazine-reading.'

- b. Ali kitap [al-dı ve sat-tı].
 Ali book buy-PST and sell-PST
 ‘Ali did book-buying and selling.’

Finally, Öztürk demonstrates that an incorporated noun allows certain types of modification (some adjectival or participial modifiers, but not relative clauses), as exemplified below (Öztürk 2005: 40):

- (15) Ali ekşi elma ye-di.
 Ali sour apple eat-PST
 ‘Ali did sour apple-eating.’

Crucial for our purposes, Öztürk further illustrates that Turkish allows PI of agent arguments with both transitive and unergative verbs, as exemplified in (16a) and (17a). The examples in (16b) and (17b) show the canonical/PI-less versions of these clauses (Öztürk 2005: 42).

- (16) a. Ali-yi arı sok-tu.
 Ali-ACC bee sting-PST
 ‘Ali got bee-stung.’ agent PI with transitive
 b. Arı Ali-yi sok-tu.
 bee Ali-ACC sting-PST
 ‘The bee stung Ali.’ canonical transitive
- (17) a. Ağaç-ta kuş ötü-yor.
 tree-LOC bird sing-IMPRF
 ‘Bird singing is happening in the tree.’ agent PI with unergative
 b. Kuş ağaç-ta ötü-yor.
 bird tree-LOC sing-IMPRF
 ‘The bird is singing in the tree.’ canonical unergative

PI’ed agents exhibit the same characteristics as those discussed for the PI of theme arguments. They allow adjacency to be broken for information structural purposes, also enabling specific focus particles to occur between the incorporated agent and the verb, as shown in (18). In contrast, if an adverb intervenes between the two in the broad focus configuration, the intended PI interpretation is no longer retained, and the agent is interpreted as a definite singular. This is illustrated by the contrast in (19).

- (18) Ali-yi arı bile sok-tu.
 Ali-ACC bee even sting-PST
 ‘Ali even got bee-stung.’
- (19) a. Ali-yi fena arı sok-tu.
 Ali-ACC bad bee sting-PST
 ‘Ali got bee-stung awfully.’ agent PI
 b. Ali-yi arı fena sok-tu.
 Ali-ACC bee bad sting-PST
 ‘The bee stung Ali awfully.’ canonical transitive

Moreover, the ellipsis of the verb and the coordination of the incorporated agent or the verb are possible, and an incorporated agent can be modified, as illustrated below:

- (20) a. Ali-yi [arı ve akrep] sok-tu.
 Ali-ACC bee and scorpion sting-PST
 ‘Ali got bee and scorpion-stung.’
 b. Ali-yi köpek [ısırdı ve yaraladı].
 Ali-ACC dog bite-PST and injure-PST
 ‘Ali got dog-bitten and dog-injured.’
- (21) Ali-yi zehirli yılan sok-tu.
 Ali-ACC poisonous snake bite-PST
 ‘Ali got poisonous snake-bitten.’

To wrap up, these facts have led Öztürk to conclude that incorporation in Turkish is manifested as PI, rather than head incorporation, and that a PI'ed argument maintains a phrasal status, as is typical in other languages where this phenomenon is observed.

On the semantic side, among the signature characteristics associated with incorporation in general are number neutrality, obligatory narrow scope, and the so-called *name-worthiness* requirement (e.g., Mithun 1984, Bittner 1994, van Geenhoven 1998, Farkas and De Swart 2003, Chung and Ladusaw 2004, Dayal 2011a). To see the case of number neutrality associated with PI first, take the contrast in (16), for instance. In (16a), we have a noun morphologically unmarked for number, *arı* 'bee', undergoing agent PI, which conveys a 'one or more bees' interpretation. This contrasts with the same unmarked noun that occurs as a canonical/non-PI'ed argument in (16b), which instead is strictly singular and definite, referring to a contextually salient unique bee individual. On the other hand, PI'ed nouns rather have a 'weak indefinite' interpretation in the sense that they obligatorily take narrow scope with respect to other scope-taking elements. This is exemplified in (22), which conveys that it is not the case that one or more bees stung Ali (i.e., that no bees stung Ali), and would be false in a situation where some bees stung Ali but some other bees did not.

- (22) Ali-yi arı sok-ma-di.
 Ali-ACC bee sting-NEG-PST
 'Ali didn't get bee-stung.' (no bees, #some bees > not)

PI exhibits varying degrees of productivity across languages where this phenomenon is observed. This has been associated with a requirement called *name-worthiness* in the literature, which dictates that the combination of a PI'ed noun and the verb yield an enriched activity or state in Mithun's (1984) terms or a canonical activity type in Dayal's (2011a) terms. Dayal illustrates this point with a contrast in Danish between 'pig-butcher,' which is a well-formed combination in terms of PI, and 'ostrich-butcher,' which is not. Given that butchering ostriches is not a common practice in Denmark, it is improbable that this activity can be considered a part of the culture, unlike the case with pig-butchering. Therefore, 'ostrich-butcher' does not emerge in the form of PI because it fails to yield a culturally significant activity in the community.

Dayal analyzes the name-worthiness requirement as a definedness condition that permits incorporation only when the resulting construction conveys a canonical activity or situation type. The name-worthiness requirement has a direct impact on the modification of the PI'ed noun, restricting it to certain adjectives that contribute to describing a canonical activity type. Sağ (2022) shows that Turkish PI'ed arguments only allow modification that counts as 'classificatory/sub-type denoting' for the PI'ed noun in its combination with the verb in compliance with this requirement. As shown in (23), book-reading is available as a form of PI when the noun is modified with *religious* and *scientific*, for example, while the modification with adjectives like *old* meaning worn-out and *small* yield a result that is awkward at best (Sağ 2022: 745). In essence, while religious or scientific book-reading can easily be considered a canonical activity type, it is harder to imagine a context where this also holds for reading worn-out or small books.

- (23) a. Ali ev-e geldikten sonra, dini/ bilimsel kitap oku-du.
 Ali home-DAT having.come after religious scientific book read-PST
 'Ali read one or more religious/scientific books.'
 b. ??Ali ev-e geldikten sonra, eski/ küçük kitap oku-du.
 Ali home-DAT having.come after old small book read-PST
 'Ali read one or more old/small books.'

We also observe a similar contrast in modification in clauses with agent PI. As we have seen in (21), the PI'ed agent 'snake' is modified with the adjective *zehirli* 'poisonous,' resulting in a well-formed PI construction. In contrast, the modification with an adjective such as *yaralı* 'wounded' in a snake-biting context results in a strictly singular definite interpretation for the agent argument, yielding a canonical transitive construction instead, as illustrated in (24).

- (24) Ali-yi yaralı yılan sok-tu.
 Ali-ACC wounded snake bite-PST
 'The wounded snake bit Ali.'
 Not: Ali got bitten by one or more wounded snakes.'

The difficulty in obtaining the intended PI interpretation in (24) stems from the fact that being bitten by a wounded snake is not a name-worthy situation. We identify at least two criteria for classifying an event as a canonical event type: one based on the typicality or frequency of the event, and the other on its significance—whether the event “matters” and is worthy of mention due to its potential impact. Specifically, in a snake-biting event, the fact that the snake happens to be wounded does not contribute to the typicality or significance of the event itself out of the blue (see fn 17). However, the type of snake involved in the event can easily classify it as a name-worthy event. First, the type of snake *matters*, as it could be crucial for treatment purposes. Being bitten by a poisonous snake is particularly dangerous, making the nature of the event significant, thereby meriting classification as a distinct category of snake-biting event. Alternatively, one could consider getting bitten by a poisonous snake as a licit event type based on the typicality or frequency of such incidents within a certain environment. For instance, imagine a village where poisonous snakes are common, and snake bites occur frequently. This scenario would make such an event a typical or canonical one, and thus easier to classify as a name-worthy event type.

In summary, Turkish permits incorporation of both theme and agent arguments, which, maintaining their phrasal status, exhibit the signature characteristics associated with this phenomenon.

2.2 Psuedo-incorporation in Laz

Let us now discuss the facts of PI in Laz. As stated above, case alignment in the Pazar/Atina dialect of Laz is active-ergative and differentiates external arguments from internal arguments. The subject of a transitive or an unergative verb is marked with the ergative case suffix. The subject of an unaccusative verb and the object of a transitive verb are in null nominative form.⁵ These patterns are exemplified below:

- (25)
- | | | |
|----|--|--------------------------|
| a. | Laç'i-k ts'ari ş-um-s.
dog-ERG water.NOM drink-IMPF-PRS.3SG
'The dog is drinking water.' | transitive |
| b. | Bere-k k'i-am-s.
child-ERG yell-IMPF-PRS.3SG
'The child is yelling.' | unergative |
| c. | Ts'ari-k şişil-am-s.
water-ERG burble-IMPF-PRS.3SG
'The water is burbling.' | unergative/emission verb |
| d. | Ts'ari kor-un.
water.NOM get.cold-IMPF.PRS.3SG
'The water is cooling down.' | unaccusative |

Analogous to Turkish, Laz allows PI of theme arguments, as demonstrated in (26). However, since canonical theme arguments are morphologically unmarked, there is no obvious morpho-syntactic indication at first sight when the theme undergoes PI. This contrasts with the case in Turkish, where we see the distinction directly through the absence of accusative case marking. Consequently, the sentence in (26) is ambiguous in being a clause with PI, where the theme gains a number neutral, non-specific/narrow scope reading, and a canonical transitive construction, where the theme is interpreted as a definite singular.

- (26)
- | | |
|---|----------------------------|
| Atlasi-k çitabi i-k'itx-u.
Atlasi-ERG book PV-read-PST.3SG
'Atlasi read one or more books./ Atlasi did book-reading.' | PI
canonical transitive |
|---|----------------------------|

Nevertheless, the difference between the two constructions becomes evident when the order of the theme and agent arguments is reversed, in which case the PI interpretation becomes unavailable:

- (27)
- | | |
|---|--|
| Çitabi Atlasi-k i-k'itx-u.
book Atlasi-ERG PV-read-PST.3SG | |
|---|--|

⁵ We will not be talking about how case forms are determined in Laz, as it is orthogonal to our discussion. See Baker and Bobaljik (2017) for relevant discussion, comparing the two prominent views on ergative: dependent and inherent.

‘Atlasi read the book.’ canonical transitive
 Not: ‘Atlasi read one or more books./ Atlasi did book-reading.’

What we are dealing with here is again PI, not head incorporation, because an incorporated argument maintains a phrasal status. More precisely, the diagnostic facts discussed above also hold for Laz. For example, while the separation of the theme argument and the verb as in (27) disrupts the PI of the theme, focus particles can intervene between the two, as illustrated in (28a). As in Turkish, scrambling of the incorporated argument for information structural purposes is also possible. That is, (27) could be felicitous if the subject is contrastively focused, for instance. Furthermore, it is possible to elide the verb, as in (28b), and both the incorporated noun and the verb can be coordinated, as seen in (29).

- (28) a. Atlasi-k çitabi ti i-k’itx-u.
 Atlasi-ERG book also PV-read-PST.3SG
 ‘Atlasi also did book_F-reading.’
 b. Ali-k çitabi i-k’itx-u, jurnali va(r).
 Ali-ERG book PV-read-PST.3SG magazine not
 ‘Ali did book-reading, not magazine (reading).’
- (29) a. Ali-k [çitabi do jurnali] i-k’itx-u.
 Ali-ERG book and magazine PV-read-PST.3SG
 ‘Ali did book-reading and magazine-reading.’
 b. Ali-k çitabi [e-ç’op-u do gama-ç-u].
 Ali-ERG book PV-buy-PST.3SG and PV-sell-PST.3SG
 ‘Ali did book-buying and selling.’

Given our primary focus on agent PI, we will now delve into the further details by discussing the properties of PI’ed agents. We argue that Laz allows the PI of agent arguments, direct evidence of which comes from its effect on ergative case. As first illustrated in Section 1, (30b) contrasts with (30a) in that the subject lacks the ergative case marker. Furthermore, the incorporated subject, which is unmarked for case, needs to occupy the immediately preverbal position. This is evidenced by its inability to be separated from the verb in the default, i.e., broad focus, word order configuration (QUD: ‘what happened’), as shown in (30c).⁶

- (30) a. Laç’i-k bere-s goyo-k’ap’-u.
 dog-ERG child-DAT over-attack-PST.3SG
 ‘The dog attacked the child.’ canonical subject
 b. Bere-s laç’i goyo-k’ap’-u.
 child-DAT dog over-attack-PST.3SG
 ‘One or more dogs attacked the child./ The child got dog-attacked.’ PI’ed subject
 c. *Laç’i bere-s goyo-k’ap’-u.
 dog child-DAT over-attack-PST.3SG

Caseless agents pass the diagnostics of PI by exhibiting the aforementioned syntactic properties associated with it. For instance, while the adjacency requirement is further evident in the inability of an adverb to intervene between the incorporated agent and the verb, as in (31a), focus particles can still cliticize on the incorporated noun, as in (31b). Additionally, an incorporated agent allows adjectival modification, as observed in (32), showing that agent incorporation in Laz is a phrase-level process rather than head incorporation:

- (31) a. Doktori*(-k) ğoma mi-yox-u.
 doctor-ERG yesterday 1.OBJ-call-PST.3SG
 ‘The doctor called me in yesterday.’
 Not: ‘I got doctor-called yesterday.’
 b. Ğoma doktori ti mi-yox-u.
 yesterday doctor also 1.OBJ-call-PST.3SG
 ‘I also got doctor_F-called yesterday.’

⁶ Note that the object in (30) is lexically DAT-marked. We call this lexical case, for objects normally appear caseless (i.e., unmarked for case, nominative). These data are important in showing that the requirement that the caseless subject occupy the immediately preverbal position is not a consequence of two caseless NPs being in the same clause.

- (32) Ham oxori usta xirsuzi go-yç'-u.
 this house master thief PV-rob-PST.3SG
 'This house got robbed by a master thief or thieves.'

Further evidence supporting the presence of agent PI in Laz is observed in the interpretation of caseless subjects that directly precede the verb. These subjects exhibit the semantic characteristics of incorporation discussed above for Turkish, including number neutrality, narrow scope indefinite interpretation, and compliance with the *name-worthiness* requirement.

To see the case of number neutrality first, let us compare the examples in (30) one more time. The subject noun *laç'i* 'dog' in the regular transitive construction given in (30a) refers to a unique dog that is familiar in the common ground and hence yields a definite singular interpretation. In contrast, the caseless subject in (30b) yields a number-neutral interpretation, referring to one or more dogs, whose identities are not necessarily part of the common ground.

The narrow scope property is illustrated with the example in (33), where the caseless subject is interpreted under the scope of negation. That is, the sentence in (33) is judged true if no dogs attacked the child and false if some dog(s) attacked the child and some other dog(s) did not.

- (33) Bere-s laç'i var goyo-k'ap'-u.
 child-DAT dog NEG over-attack-PST.3SG
 'No dogs attacked the child.' (#some dogs > not)

In short, while an agent NP that is unmarked for number yields a definite singular interpretation when occupying a case-marked argument position, a caseless agent NP that is (necessarily) immediately preverbal is construed number-neutrally and exhibits a narrow scope indefinite behavior.

Finally, agent PI in Laz is also subject to the name-worthiness requirement, much like in Turkish or other languages allowing PI, influencing the permissible types of modification. The modification of *xirsuzi* 'thief' with *usta* 'master' yields a well-formed PI construction since this combination denotes a type of thief—a skillful one—thereby creating a situation where the type of thieves involved in a robbery matters. In other words, being robbed by skillful thieves can have notable consequences, making it a name-worthy event that qualifies as a canonical event type. In contrast, it is much harder for the intended PI reading to arise when the PI'ed noun is modified by an adjective like 'fat,' as seen in (34). This is because being robbed by a fat thief or thieves does not, in any obvious way, contribute to the name-worthiness of the situation. As our consultant notes, (34) requires the ergative case on the agent NP to result in a well-formed structure, where the modified agent would refer to a unique fat thief that is familiar in the common ground.

- (34) ??Ham oxori çuntu xirsuzi go-yç'-u.
 this house fat thief PV-rob-PST.3SG
 'This house got robbed by a fat thief or thieves.'

Having explored the syntactic and semantic properties of PI'ed arguments in Turkish and Laz, we are now ready to address the initial questions about the preservation of transitivity in structures featuring agent PI.

3 Pseudo-incorporation and Two-layered Verbal Structure

We have seen that clauses with agent PI yield a linear order where the theme argument precedes the agent. Assuming that the linear order is a reflection of the hierarchical relation among the arguments, this order is at odds with The Uniformity of Theta Assignment Hypothesis (UTAH), originally proposed in Baker (1988):

- (35) The Uniformity of Theta Assignment Hypothesis (UTAH):
 Identical thematic relationships between items are represented by identical structural relationships between those items at the level of D-structure. (Baker 1988: 46)

UTAH universally requires that the verb and the theme NP form a constituent to the exclusion of the agent NP, which instead asymmetrically c-commands the theme. In clauses with agent PI, this relation seems to be reversed. The first step in our analysis is to show that this apparent violation is merely superficial and that clauses with agent PI do not necessarily contradict UTAH.

Following a neo-Davidsonian framework, where not only the agent argument but also the theme is severed from the verb, we adopt a two-layered verbal structure (Öztürk 2005 and Sağ 2019, 2022): (i) the lexical domain of VP, which hosts incorporated arguments, and (ii) the VP-external functional domain, where canonical arguments are introduced (themes via a little v_{Th} head projecting above the VP and agents via a higher little v_{Ag} head). We further argue that UTAH applies in the VP-external domain independently of the VP-internal domain, and hence the reversed thematic order in agent PI does not violate UTAH, contrary to appearances. The rationale for these claims is rooted in the semantics of PI, which we turn to next.

3.1 Pseudo-incorporation and Event Kinds

The semantics of incorporation has been the focus of several studies (e.g., Bittner 1994, van Geenhoven 1998, Farkas and De Swart 2003, Dayal 2011a, 2015). Among them, Dayal (2011a, 2015) claims that singular nouns that undergo PI in Hindi and Hungarian denote atomic properties, and the number neutral interpretation is independently made available through atelic or habitual aspectual specification. In her view, an atelic interpretation involves the presence of multiple sub-events within a single event, while habituality necessitates a plural quantificational domain. In both cases, each sub-event within an iterative context or each sub-event making up the atomic part of a plural quantificational domain within a habitual structure features a singular individual as its theme argument. For instance, in an iterative context, ‘Anu mouse-caught,’ denotes that there is an event E comprising sub-events of mouse-catching, with Anu as the agent for each, and each sub-event of catching involving a mouse as its theme. Dayal’s evidence comes from the fact that in telic contexts — in particular, with telic adverbial modification — a PI’ed noun yields a strictly singular interpretation.

Sağ (2019, 2022) shows that in Turkish number neutrality of PI’ed singular nouns is not contingent on aspectual specification unlike in Hindi and Hungarian; instead, it stems from singular kind reference.⁷ The lack of sensitivity to aspectual specification is evidenced by the example in (36), where the PI’ed noun yields a number neutral reading in a telic context (Sağ 2022: 755):

- (36) a. Ali yarım saat-te **adam** bul-muş/ topla-muş.
 Ali half hour-LOC man find-EVID/ collect-EVID
 ‘Ali found one or more people (for a job, fight, etc) in half an hour.’
 b. Bir baktık, on kişiyle geliyor. Halbuki biz onun bir kişi bile bulabileceğinden emin değildik.
 ‘All of sudden, he came with ten people. In fact, we weren’t even sure that he could find a single person.’

To understand how the number neutrality of PI’ed singular nouns arises from singular kind reference, let us briefly overview the semantics of kind terms. In Turkish, both plural and singular nouns can refer to kind individuals, as evidenced by their ability to be arguments of a kind-level predicate like ‘evolve’:

- (37) **Dinozor(-lar)** 250 milyon yıl önce evrimleş-ti.
 dinosaur-PL 250 million year ago evolve-PST
 ‘The dinosaur/Dinosaurs evolved 250 million years ago.’

Sağ follows Chierchia (1998) in that plural kind terms are derived via the covert type-shifting operator \cap . The \cap operator takes a plural property and returns the individual correlate of that property, a function from worlds w to the maximal entity satisfying the property in w . This intensional entity is a kind individual (e.g., the dinosaur kind) and it is derived from the corresponding property (e.g., the property of being a dinosaur), as illustrated below.⁸

- (38) \cap dinozorlar: = $\lambda w. \iota x. *dinosaur_w(x)$
 \rightsquigarrow a function from worlds w to the maximal entity satisfying the dinosaur property in w

⁷ In other views of PI, such as the ‘Restrict’ analysis proposed in Chung and Ladusaw (2003), the number neutrality of PI’ed nouns can only be derived if these nouns have a number neutral property denotation. Sağ (2019, 2022) has shown that singular nouns in Turkish denote singular properties or singular kind terms, as discussed next, arguing against the number neutral view, which has been defended earlier in Bliss (2004), Bale et al (2010), and Görgülü (2012).

⁸ See also Carlson (1977), the kind literature builds on the Carlsonian view.

On the other hand, building on Dayal’s view of English singular nouns, Sağ takes singular kind terms as primitive entities that directly refer to a kind entity in the taxonomic domain. In Dayal’s view, a singular noun is ambiguous in denoting an atomic property of object-level entities, as in (39), and an atomic property of kind-level/taxonomic entities, as in (40). In their taxonomic sense, singular nouns can either denote a singleton set containing a unique kind individual (e.g., the dog kind), as in (40a), or an atomic set containing the sub-kinds of a kind individual (e.g., the bulldog, the poodle, etc.), as in (40b), depending on the context. (Following the convention in the literature taxonomic kind individuals are represented with capitals.)

- (39) $\llbracket dog \rrbracket = \lambda x. dog(x) = \{Fido, Max, Tommy...\}$ $\langle e, t \rangle$
- (40) a. $\llbracket dog_{k,c} \rrbracket =$ a singleton set containing the dog kind $= \{DOG\}$
 b. $\llbracket dog_{k,c} \rrbracket =$ a set of subkinds of dog salient in a context c
 $= \{BULLDOG, POODLE, GOLDEN.R, \dots\}$ $\langle e_k, t \rangle$

For example, in (41), the bare singular *köpek* ‘dog’ denotes at the ordinary object level, and in (42), it denotes at the taxonomic domain. In both cases, the singular noun is a definite description, referring to contextually salient unique dog individual in (41) and the unique dog kind in (42), through covert *iota* type-shifting due to the lack of a definite article in Turkish:⁹

- (41) a. Köpek bana saldır-dı.
 dog to.me attack-PST
 ‘The dog attacked me.’
 b. $\iota(\llbracket köpek \rrbracket) = \iota x. dog(x) = Fido$
- (42) a. Köpek insan-ın can dostu-dur.
 dog human-GEN life friend-GENERIC
 ‘The dog is the best friend of humans.’
 b. $\iota(\llbracket köpek_{k,c} \rrbracket) = \iota x_k. dog_k(x_k) = DOG$

Singular and plural kind terms differ in their ability to grant access to object-level entities. Plural kind terms can be type-shifted to sets of object-level instances via *pred*^U. As shown in (43), *pred* takes a plural kind term and returns a set of atomic and plural individuals that are object-level instances of the kind.

- (43) For any world w , where $\iota x. *dinosaur_w(x)$ is the plural individual that comprises all of the atomic instances of the dinosaur kind in w
 $\cup \cap \text{dinozorlar}: \lambda y. y \leq \iota x. *dinosaur_w(x)$
 \rightsquigarrow the set of singular and plural entities that are part of the maximal instance of the kind in w

In contrast, a type-shifting operator of this sort is not available for singular kind terms. In this way, they are akin to group terms like *team* and *committee*. Groups, though conceptually plural, are impure atomic entities and thus do not have parts, as defined by Landman (1989). Singular kind terms then contrast with plural kind terms, which instead denote pluralities and thus have parts, as reflected in the outcome of *pred* in (43). An immediate consequence of this distinction becomes apparent when we consider the combination of singular and plural kind terms with distributive elements. In (44a), both the plural and the singular form of the noun *ayı* ‘bear’ convey a plural/number-neutral interpretation because (44a) describes a property attributed to the whole bear kind and kinds are conceptually plural entities. However, unlike plural kind terms, singular kind terms are not compatible with predicates that involve a reciprocal relation between individual members of the species, as in (44b), due to their grammatically atomic nature.

- (44) a. **Ayı(-lar)** genelde saldırıgan ol-ur.
 bear-PL generally aggressive be-AOR
 ‘The bear is/Bears are generally aggressive.’

⁹ The sub-kind denotation as in (40b) is evident in the example below, where *kuş* ‘bird’ denotes an atomic set of sub-kinds of the bird kind and the numeral quantifies over this set.

- (i) İki kuş-un nesli tükenmek üzere.
 two bird-GEN go.extinct about.to
 ‘Two birds are about to go extinct.’

- b. **Kedi*(-ler)** birbiri-ne saldır-ır.
 cat-PL each.other-DAT attack-AOR
 ‘Cats attack each other.’
 *‘The cat attacks each other.’

To frame it as described by Dayal, unlike plural kind terms, singular kind terms are grammatically singular but conceptually plural in that they hold a relation to atomic and plural object-level entities associated with kinds. However, this relation is not established in the grammatical component through a type-shifting operator, unlike the case with plural kind terms. Instead, Sağ argues that the conceptual relation between a taxonomic kind and the object-level entities associated with it, which she names *belong-to*, is operative in PI. That is, the argumentation process in PI forms a *belong-to* relation between a thematic argument of the verb and the referent of a singular kind term. PI, defined for singular kinds only, denotes a canonically recognizable type of event, a thematic argument of which is a member of (*belongs to*) a kind entity. Establishing this relation is what derives a number-neutral interpretation with PI’ed singular nouns in Turkish.

In a more recent study, Sağ (2024), building on the interaction of PI and the lexical aspect, argues that PI is an argumentation process that occurs at the level of event kinds, following the theories positing event kinds (represented as e_k of type v_k), as a distinct category from event tokens (represented as e of type v) (Barwise and Perry 1983, Landman and Morzycki 2003, Ginzburg 2005, Schäfer 2007, Gehrke and McNally 2011, Schwarz 2014, Anderson and Morzycki 2015, Gehrke 2015, Sağ 2018, Luo 2022, and references therein). In this view, verbs can denote properties of event kinds in addition to the general assumption that they can denote properties of event tokens:¹⁰

- (45) a. $\llbracket read_{kind} \rrbracket = \lambda e_k. read_k(e_k)$
 b. $\llbracket read_{token} \rrbracket = \lambda e. read(e)$

Expanding on this two-layered view of the event domain, we see that just as argument saturation occurs with event tokens, it is also possible with event kinds. The latter manifests itself in the form of PI in languages like Turkish (see also Espinal and McNally 2011, Gehrke 2015, Sağ 2018, Luo 2022, cf. Farkas and De Swart 2003, Chung and Ladusaw 2004, Dayal 2011b, Modarresi 2014, Krifka and Modarresi 2016, a.o.). The argument position of an incorporating verb, which denotes at the level of event kinds, can only be filled by a kind-denoting argument, i.e., a singular kind term, and the outcome yields a sub-event kind interpretation.¹¹ This deep-level argumentation happens VP-internally. Adopting a neo-Davidsonian framework, it is assumed that there are token-level and kind-level thematic functions (represented as θ_t and θ_k). Argumentation in the event kind domain occurs through a θ_{kind} head (e.g., theme introducing Th_{kind}), which denotes a thematic function defined on singular kinds and event kinds.¹² The θ_{kind} head and the lexical V form a complex V head, which then takes the PI’ed NP as its complement. In light of this view, the PI construction *book-read* in (46) is derived as illustrated below:

¹⁰ Event kinds can be derived in two ways: One approach is to assume that they are derived through a *nom* operator that applies to properties of event tokens, as proposed in Chierchia (1998) and Schwarz (2014). Alternatively, we can consider event kinds as primitive entities, similar to singular kind terms in the nominal domain, as proposed in Schäfer (2007) and Gehrke and McNally (2011). Sağ (2024) argues that PI builds taxonomic event kinds, as detailed below. Therefore, event kinds are analyzed as primitive entities, analogous to Dayal’s analysis of taxonomic kinds in the nominal domain.

¹¹ Sağ (2022) shows that plural kind terms do not undergo PI in Turkish. We remain agnostic regarding the cross-linguistic validity of this claim. See Dayal (2004), where Hindi and Hungarian are argued to allow PI with plurals.

¹² In Sağ’s system, only VP-internal thematic functions (θ_k) have presuppositions—they are defined on singular kind arguments and properties of event kinds—while VP-external thematic functions (θ_t) are not restricted in this way. θ_k ensures that only singular kinds can be thematic arguments in the event kind domain, given that plural kind terms are not PI’ed in Turkish, as mentioned in fn. 11. That θ_k is defined on event kinds also rules out the possibility of a verb entering into the derivation directly denoting an event token and combining with a singular kind argument in the VP-internal domain (see fn 14). This combination is only possible above the VP, as in (37), where singular kind arguments receive case and do not yield a sub-event kind interpretation. Consequently, the VP-external event token domain theta functions accept both object-level and kind-level arguments depending on whether the predication is an object-level or kind-level one (e.g., *evolve* yields a kind-level predication as it denotes a property that can be attributed to a kind entity). θ_t does not need to be defined exclusively for event tokens either due to being always inserted above ET. The subscripts k and t on θ reflect where theta functions are introduced relative to ET. See Sağ (2022, 2024) for interpretational distinctions between case-marked kind terms (introduced in the event token domain) and caseless singular kind terms (introduced in the event kind domain).

- (46) Ali kitap oku-du.
 Ali book read-PST
 ‘Ali did book-reading.’

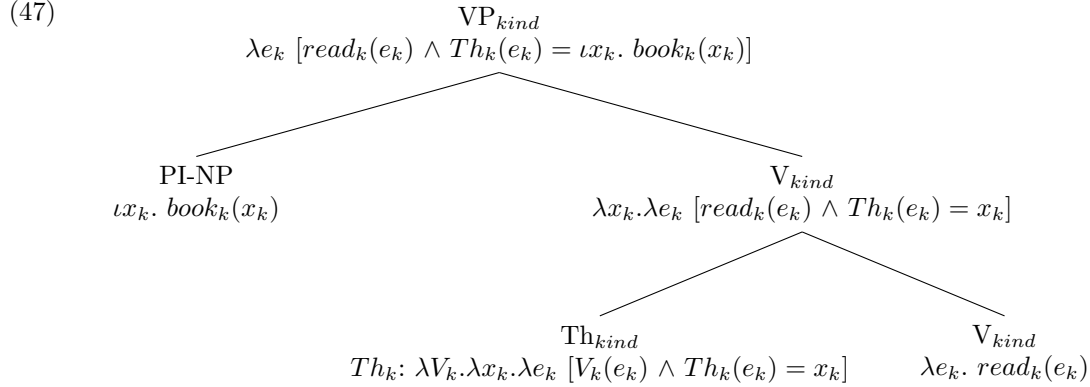

The Th_{kind} head denotes a thematic function (Th_k) that operates at the level of event kinds. It takes the property of an event kind V_k of type $\langle v_k, t \rangle$ and a singular kind term to denote the property of an event kind with a theme argument that is a singular kind individual. The PI structure derived in (47) denotes the property of the reading event kind with the book kind as its theme. The outcome is the property of the book-reading event kind, which is a sub-kind of the reading event kind. More precisely, PI is a means of establishing the taxonomy of event kinds through their combination with kind-level thematic arguments (cf. Espinal and McNally 2011).

The next step is to combine this sub-event kind with the agent argument, i.e., *Ali*, to yield an interpretable sentence. To introduce an event-token level argument, we need a mechanism to shift from the event-kind domain to the domain of event tokens. This shift is ensured by Event Tokenizer (ET), as defined in (48).

- (48) ET: $\lambda V_k. \lambda e. \exists e_k [belong\text{-}to(e, e_k) \wedge V_k(e_k)]$

ET takes an event-kind property (V_k of type $\langle v_k, t \rangle$), existentially closes it, and returns a property of event tokens (V of type $\langle v, t \rangle$) that belong to the event kind. (As event kinds are taxonomic, they hold a *belong-to* relation with event tokens, akin to singular kinds.) For example, the VP ‘book-read’, when shifted to the event token domain, as demonstrated below, denotes a property of reading event tokens that belong to the reading event kind whose theme argument is the book kind:

- (49) ET([book-read]) = $\lambda e. \exists e_k [belong\text{-}to(e, e_k) \wedge [read_k(e_k) \wedge Th_k(e_k) = \iota x_k. book_k(x_k)]]$

The existence of an event token derived through ET type-shifting entails that for any thematic kind argument that the event kind has (if any), there is an object-level individual or individuals that are members of that kind argument, and these individuals hold the same thematic role in the event token domain as the kind argument does in the event kind domain. This entailment is posited to arise from an axiom called Event Tokenization in Sağ’s analysis, as illustrated in (50). For example, involvement in a book-reading event kind requires a reading event token with at least one book as its theme.

- (50) **Event Tokenization**
 $\forall e_k, x_k, \theta_k [\theta_k(e_k) = x_k \rightarrow [\forall e, \theta_t [belong\text{-}to(e, e_k) \wedge correspond\text{-}to(\theta_t, \theta_k)] \rightarrow \exists y [belong\text{-}to(y, x_k) \wedge \theta_t(e) = y]]]$

Canonical argumentation, as stated above, occurs only after event kinds type-shift to event tokens, which takes place at the level of the VP. Given that the event kind-level argumentation, i.e., PI, occurs in the VP-internal domain, event token-level theme arguments are introduced by a theme introducing little v head

(represented as v_{Th}), and event token-level agent arguments are introduced by a separate agent introducing little v head (represented as v_{Ag}) projecting above v_{Th} , as schematized below:¹³

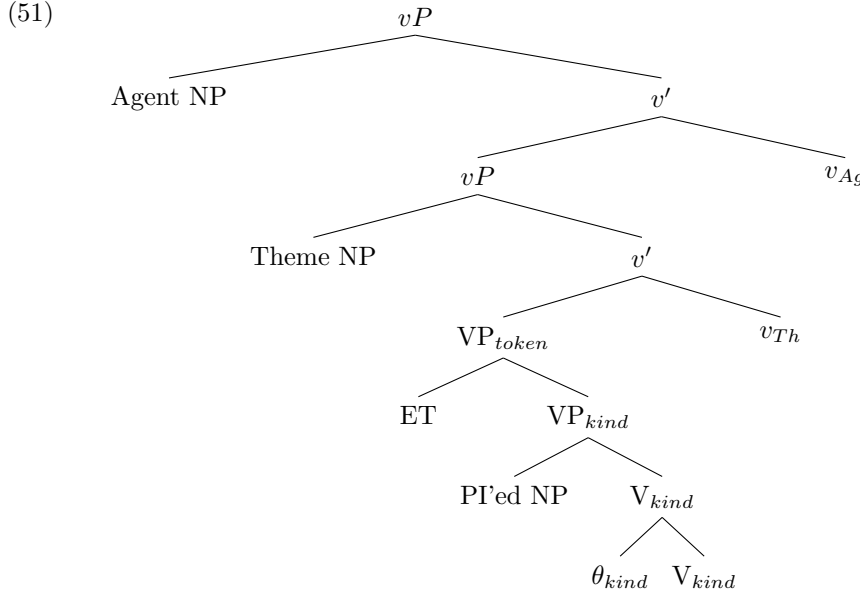

Returning to the structure of (46), v_{Ag} projects above the VP to introduce the agent argument *Ali*, as shown below:

- (52)
- $\llbracket v_{Ag} \rrbracket = Ag_t : \lambda V. \lambda x. \lambda e [V(e) \wedge Ag_t(e) = x]$
 - $\llbracket [v' [v_{Ag}] [VP]] \rrbracket = \lambda x. \lambda e. \exists e_k [belong\text{-}to(e, e_k) \wedge [read_k(e_k) \wedge Th_k(e_k) = \iota x_k. book_k(x_k)] \wedge Ag_t(e) = x]$
 - $\llbracket [v_P \text{ Ali } [v' [v_{Ag}] [VP]]] \rrbracket = \lambda e. \exists e_k [belong\text{-}to(e, e_k) \wedge [read_k(e_k) \wedge Th_k(e_k) = \iota x_k. book_k(x_k)] \wedge Ag_t(e) = \text{Ali}]$

Ignoring tense, the event variable eventually undergoes existential-closure, and thus the denotation of (46) is as shown below. ‘Ali did book-reading’ means that Ali is involved in an event token that belongs to the book-reading event kind as an agent. Being involved in an event token that belongs to the book-reading event kind entails that there is a reading event whose theme argument belongs to the book kind.

- (53) $\llbracket (46) \rrbracket = \exists e. \exists e_k [belong\text{-}to(e, e_k) \wedge [read_k(e_k) \wedge Th_k(e_k) = \iota x_k. book_k(x_k)] \wedge Ag_t(e) = \text{Ali}]$
 (entails: $\exists e. \exists y [read(e) \wedge belong\text{-}to(y, \iota x_k. book_k(x_k)) \wedge Th_t(e) = y \wedge Ag_t(e) = \text{Ali}]$)

For comparison, let us consider canonical argumentation, as in (54), where both the agent and the theme arguments are introduced VP-externally in the event token domain. Here, *kitap* ‘book’ is introduced in the specifier position of v_{Th} and denotes an atomic property at the ordinary object level, which subsequently undergoes *iota* type-shifting to denote a contextually familiar unique book individual. The agent NP *Ali* is merged higher in the specifier of v_{Ag} . The sentence then means that Ali was involved in a reading event token whose theme is a definite book individual.¹⁴

¹³ The structure in (51) represents the PI’ed argument simultaneously with an agent and a theme argument in the VP-external domain. The reader should view this as a preliminary illustration of where thematic arguments would be positioned if they were inserted in the event kind or token domains. We will revisit and clarify this representation in Section 5 and 7.

¹⁴ The question of whether verbs denote the property of an event kind in the absence of PI is a subject of debate. One could hypothesize that, in cases where no argumentation occurs in the event kind domain, a verb enters the derivation as a property of event tokens. This avoids the additional step of ET type-shifting but introduces a look-ahead problem. A similar question arises for non-PI languages: Do their verbs ever denote the property of event kinds? Building on this, in these languages, it is not immediately evident whether we should introduce a v_{Th} head or simply add the theme argument as a complement to the V head. Sağ (2022) argues that the so-called weak definites (e.g., ‘Lola read the newspaper’) are singular kind terms (following Aguilar-Guevara and Zwarts 2010) and instances of PI (following Carlson and Sussman 2005 and Carlson 2006), which exhibit limited productivity in English compared to Turkish. This suggests that a similar two-layered structural configuration exists at least in the English verbal domain.

- (54) a. Ali **kitab-1** oku-du.
 Ali book-ACC read-PAST
 ‘Ali read the book.’

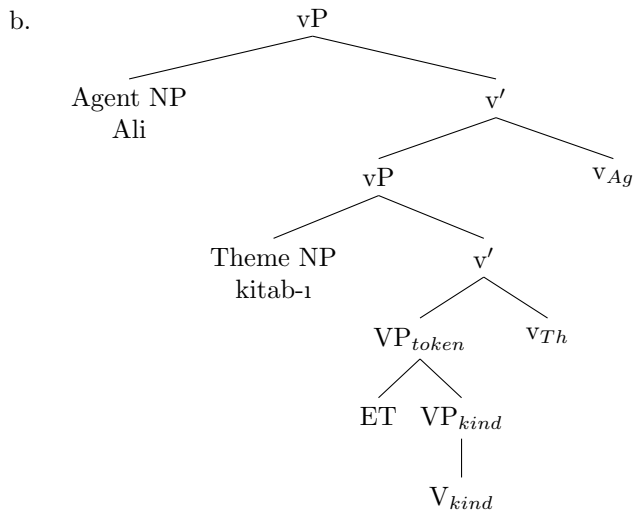

- c. $\exists e. \exists e_k [belong\text{-}to(e, e_k) \wedge read_k(e_k) \wedge Th_t(e) = \iota x. book(x) \wedge Ag_t(e) = Ali]$
 $\Rightarrow \exists e [read(e) \wedge Th_t(e) = \iota x. book(x) \wedge Ag_t(e) = Ali]$

Clauses with agent PI differ from clauses with theme PI only in that the incorporating verb receives an agent argument at the level of event kinds, i.e., inside the VP, instead of a theme argument. The theme NP is introduced at the event token domain above the VP via v_{Th} head. Let us consider the example in (55), the structure of which is as represented in (56).

- (55) Ali-yi köpek ısır-dı.
 Ali-ACC dog bite-PST
 ‘Ali got dog-bitten.’

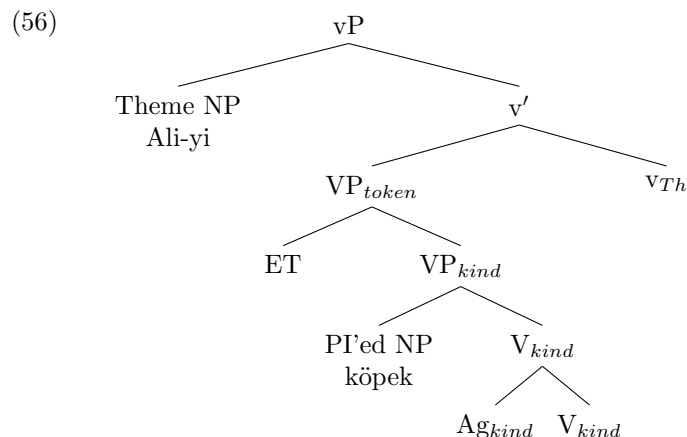

The denotations of the VP before and after it undergoes ET type-shifting are illustrated below:

- (57) a. $\llbracket [VP_{kind} \text{ dog-bite}] \rrbracket = \lambda e_k [bite_k(e_k) \wedge Ag_k(e_k) = \iota x_k. dog_k(x_k)]$
 b. $ET(\llbracket [VP_{kind} \text{ dog-bite}] \rrbracket) = \llbracket [VP_{token} \text{ dog-bite}] \rrbracket = \lambda e. \exists e_k [belong\text{-}to(e, e_k) \wedge bite_k(e_k) \wedge Ag_k(e_k) = \iota x_k. dog_k(x_k)]$

The incorporating verb ‘bite’ which denotes the property of the biting event kind takes an agent argument, i.e., the dog-kind, through its combination with the Ag_{kind} head, which denotes an agent introducing thematic function at the level of event kinds (Ag_k). As shown in (57a), the outcome is the property of a sub-kind of the biting event kind, i.e., the *dog-bite* event kind, which we roughly translate into English as ‘getting dog-bitten.’

This $\langle v_k, t \rangle$ type expression is then type-shifted to a property of event tokens, a $\langle v, t \rangle$ type expression, which denotes a set of event tokens that belong to the getting dog-bitten event kind. Consequently, the theme argument, *Ali*, is introduced to denote the following proposition:

$$(58) \quad \begin{aligned} \llbracket (55) \rrbracket &= \exists e. \exists e_k [\textit{belong-to}(e, e_k) \wedge [\textit{bite}_k(e_k) \wedge \textit{Ag}_k(e_k) = \iota x_k. \textit{dog}_k(x_k)] \wedge \textit{Th}_t(e) = \textit{Ali}] \\ &\Rightarrow \exists e. \exists y [\textit{bite}(e) \wedge \textit{belong-to}(y, \iota x_k. \textit{dog}_k(x_k)) \wedge \textit{Ag}_t(e) = y \wedge \textit{Th}_t(e) = \textit{Ali}] \end{aligned}$$

The formula in (58) informally means that Ali was involved in the getting dog-bitten event kind, which entails the existence of one or more dogs as the agent of the bite that Ali has experienced.

As we have seen, the number neutrality of PI'ed arguments stems from their being kind terms. In Sağ's PI analysis, the narrow scope property of PI'ed arguments is predicted because the singular kind denoted by the PI'ed NP is part of the event kind denoted by the VP complex. Quantification over event kinds, as a result of ET type-shifting, is embedded under quantification over event tokens. Since the existential closure of the event (token) variable always occurs under the scope of other quantificational elements (e.g., Kratzer 1998), the event kind quantifier, and thus the PI'ed NP, is necessarily interpreted low.

The name-worthiness requirement is not an *ad hoc* condition but rather a natural consequence of PI targeting taxonomically construed event kinds (cf. Gehrke 2015). More precisely, kind entities in general identify classes of objects with a sufficiently regular function or behavior in nature; however, singular kind terms, unlike the plural form, are constrained to refer to well-established, i.e., "name-worthy" kinds (Carlson 1977). This distinction is illustrated in (59), where the definite DP *the coke bottle* has a kind-level interpretation due to its association with a prototypical bottle type. In contrast, *the green bottle* resists a similar reading, likely because the modifier 'green' does not track a stable taxonomic category—perhaps due to the fact that green bottles vary too widely in shape and size. Notably, this restriction disappears in the plural, where both *coke bottles* and *green bottles* are acceptable, suggesting that plural kind terms do not require the same degree of taxonomic cohesion.

- (59) a. The coke bottle/#The green bottle has a narrow neck.
 b. Coke bottles / Green bottles have narrow necks. (Krifka et al 1995:11)

Similarly, taxonomic event kinds must correspond to some sort of well-established, i.e., typically encountered or impactful, classes of events, mirroring the constraints observed with nominal kind reference. Therefore, what counts as a taxonomic event kind is highly culture and context-dependent. When we reconsider the 'pig-butcher' vs. 'ostrich-butcher' distinction, it is unsurprising that Danish speakers do not categorize 'ostrich-butcher' as a sub-event kind of butchering due to the rarity or non-existence of ostrich-butchering in their culture, whereas this is plausible with the commonly attested event of pig-butchering.

The restriction in modification with PI'ed nouns is also tied to the taxonomic kind-denoting nature of PI constructions. Since PI'ed nouns are singular/taxonomic kind terms, their modification is only possible via sub-kind denoting/taxonomic modifiers. Additionally, since the outcome of PI should denote a taxonomic event kind, what modifier counts as taxonomic also depends on the combination of the PI'ed noun and the verb.¹⁵ For this, let us reconsider the contrast in modification discussed above:

¹⁵ A reviewer questions why participants in event kinds must be kinds, distinguishing this from the question of why we analyze them this way. They ask, for instance, what prevents there being an event kind with an object-level argument—e.g., the event kind of "intentionally fouling Shaquille O'Neal" or "unwittingly driving too tall a truck down Storow Dr in Boston, MA," both of which they note as name-worthy events. While we recognize the importance of this deeper "why"-question—whose answer may lie in broader ontological considerations—a philosophical explanation falls beyond the scope of this paper. However, we emphasize that the event-kind analysis of PI is grounded in empirical patterns. As discussed above, PI displays name-worthiness and modification restrictions that point to taxonomic event kinds, requiring taxonomic kind participants. Relevant to the reviewer's concern, Turkish allows proper names of well-known books, TV series, or movies to appear in PI constructions (without case marking) (Sağ 2019). For example, *Nil bu aralar Suç ve Ceza okuyor* ('Nil is doing Crime and Punishment-reading nowadays') is acceptable because this book can be coerced into a well-established sub-kind (e.g., of the book kind). This is possible because the name refers to a culturally popular and well-known work, and its object-level content (e.g., chapters) can be treated as belonging to the kind, making it a conceptually plural (or more precisely, mass-like) entity. By contrast, a proper name like *Atatürk* resists such coercion despite the prominence of its referent and the cultural significance of commemorating him in Turkish society. A sentence like *Bugün, her yıl olduğu gibi, Atatürk*(-ü) andık* ('As every year, we commemorated Atatürk today') is infelicitous without accusative case because Atatürk cannot be construed as a taxonomic kind and thus yields an undefined PI construction (see fn 12). This is because there are no plural object-level entities associated with Atatürk that could support a kind-level interpretation. Similarly, "intentionally fouling Shaquille O'Neal" may be name-worthy but would not support PI, since the theme cannot be construed as a kind. 'Unwittingly driving too tall a truck down Storow Dr,' however,

- (60) a. Ali-yi zehirli yılan sok-tu.
 Ali-ACC poisonous snake bite-ACCT
 ‘Ali got poisonous snake-bitten.’
 b. Ali-yi yaralı yılan sok-tu.
 Ali-ACC wounded snake bite-ACCU
 ‘The wounded snake bit Ali.’
 Not: Ali got stung by one or more wounded snakes.’

The modification of the PI’ed noun ‘snake’ with ‘poisonous’ is well-formed, while the modification with ‘wounded’ is not, in the intended PI interpretation. Under the taxonomic event kind treatment of PI, this distinction arises for the following reason: The adjective ‘poisonous’ is considered a sub-kind forming modifier for the snake kind as the combination denotes the poisonous kind of snake.¹⁶ Additionally, as discussed earlier, ‘poisonous snake’ is a suitable agent argument for the biting event kind because the result denotes a well-established/name-worthy sub-kind of the event kind of getting snake-bitten. However, ‘wounded snake’ does not correspond to a sub-kind/sub-category of snake out of the blue, and hence getting wounded snake-bitten does not yield a sub-event kind interpretation.¹⁷

It is crucial to highlight that in the event-kind-based semantics of PI adopted here, the concurrent incorporation of agent and theme arguments is not ruled out, yet, to the best of our knowledge, this is not attested (cf. Jo and Palaz 2022). Take the example in (61). Although children being bitten by dogs could be considered relatively typical and thus name-worthy in the Turkish culture, only the theme NP receives a PI interpretation. The agent *köpek*, on the other hand, is interpreted as a definite singular.

- (61) Köpek çocuk ısır-dı.
 dog child bite-PST
 ‘The dog did child-biting.’ (Roughly: The dog attacked a child/children.)
 Not: ‘An event of a dog/dogs biting a child/children happened.’

We interpret the unavailability of such a double occurrence of PI as an indication that the VP-internal domain contains a single argument slot, which is the complement position of the verb, and that both the theme and the agent occupy this position when they are PI’ed. In other words, the lack of simultaneous PI with theme and agent arguments is due to structural reasons, independent of the semantics of PI.¹⁸

Before concluding this section, we briefly demonstrate that Laz (an articleless language) allows both singular and plural kind reference, as exemplified in (62) (cf. with (37) and (44a)). Additionally, singular

does allow PI (i.e., lit. ‘tall truck drive’) within this context, since driving tall trucks on roads with height restrictions—such as Storrow Dr —has impactful consequences that warrant the categorization of tall truck as a recognizable sub-kind. Thus, while PI constructions must denote name-worthy event kinds, not all name-worthy events are construed as such.

¹⁶ The poisonous kind/category of snake corresponds to the supremum of all the poisonous snake kinds in the taxonomic hierarchy. Therefore, Ali’s getting bitten by any of these snake kinds would make the sentence in (60a) true.

¹⁷ Taxonomic kinds are not necessarily only the biologically well-established kinds. Taxonomy is taken as a mental classification/categorization that is context and situation-dependent. As discussed in Section 2.1, being bitten by poisonous snakes is established as a remarkable category (e.g., in a situation where the treatment may depend on whether the snake is poisonous) unlike being bitten by wounded snakes. However, imagining a situation where the latter can be sub-categorized under getting snake-bitten, while a harder task, is not impossible. Consider a culture where there is a tribe in which being bitten by snakes is a typical event and the tribe holds the belief that being bitten by wounded snakes marks a person as a member of the hunting team. In such a scenario, then wounded snakes would correspond to a well-established sub-category of the snake kind and consequently being bitten by wounded snakes could count as a name-worthy event, i.e., an event kind.

¹⁸ The event-kind-based semantics predicts that PI of arguments other than the theme and agent could also be possible. In line with this, an anonymous reviewer observes that (i) may exemplify the PI of a goal NP (cf. Sağ 2019, Jo and Palaz 2022):

- (i) Bu yıl Sevgi-yi okul-a gönder-me-di-k.
 this year Sevgi-ACC school-DAT send-NEG-PST-1PL
 ‘We didn’t send Sevgi to school this year.’

While we are not fully committed to classifying such examples as instances of PI, they do exhibit PI-like characteristics such as number-neutrality and name-worthiness. Yet, the key syntactic reflex of PI, i.e., caselessness, is missing, for the goal NP retains its dative case. Although we do not offer a thorough investigation of how goal NPs are integrated into the structure, in Section 7, we discuss and assume Baker and Vinokurova’s (2010) account, where dative is analyzed as dependent case in Turkish. However, note that while there is strong evidence for such an analysis for how dative shows up on causer NPs, it is less clear if B&V’s analysis should extend to goal NPs, since dative also appears on goals of intransitive motion verbs like “go.” Given this, it is plausible that the dative in (i) is a semantic case, which would explain why it is preserved if PI has occurred.

kind terms in Laz, akin to Turkish, display a grammatically atomic nature, distinguished from plural kind terms by their incompatibility with reciprocals, as evident in (63) (cf. with (44b)).

- (62) a. Laç'i(-epe) mgeri(-epe)-şa mo-xt-u.
 dog-PL.NOM wolf-PL-FROM PV-come-PST.3SG
 'The dog/Dogs evolved from the wolf/wolves.'
 b. Mtuti(-epe) p'anda mşk'omule on.
 bear-PL always hungry be.3SG
 'The bear is/Bears are always hungry.'
- (63) a. ***K'at'u-k** k'at'i k'at'i-s ko-n-u-k'ap-am-s.
 cat-ERG each other-DAT AFF-PV-APPL-attack-IMP-PRS.3SG
 '*The cat attacks each other.'
 b. **K'at'u-pe-k** k'at'i k'at'i-s ko-n-u-k'ap-am-an.
 cat-PL-ERG each other-DAT AFF-PV-APPL-attack-IMP-PRS.3PL
 'Cats attack each other.'

Given that kind reference is also available in Laz and shares similarities with kind reference in Turkish, we analyze PI in these languages uniformly.

To summarize, we have discussed and adopted an event-kind-based approach to the semantics of PI. In a nutshell, argumentation occurs at the level of both event kinds and event tokens, which happen VP-internally and VP-externally, respectively. PI is the argumentation process that happens in the event kind domain.

3.2 Implications of the Two-Layered Event Domain: Modification and Argumentation

Positing a two-layered event domain carries implications in two key aspects related to modification and argumentation within these domains. We start by demonstrating that VP modification at the event kind level differs markedly from VP modification at the event token level in Turkish. More critically, this framework forms the basis of one of our primary objectives: offering an explanation of UTAH within the proposed system.

3.2.1 Event Kind-Level Modification

In Section 2.1, we discussed a contrast between PI'ed and canonical, case-marked arguments in terms of adverbial modification. As reiterated in (64), while a case-marked argument can precede or follow an adverb such as *hızlıca* ('fast/quickly'), a PI'ed argument must follow the adverb. We have interpreted this as evidence for the adjacency requirement imposed on PI.

- (64) a. Ali [hızlı-ca] kitab-ı [hızlı-ca] oku-du.
 Ali fast-ADV book-ACC fast-ADV read-PST
 'Ali read the book fast.'
 b. Ali [hızlı-ca] kitap [*hızlı-ca] oku-du.
 Ali fast-ADV book fast-ADV read-PST
 'Ali read one or more books fast./Ali did fast book-reading.'

However, there is another form of verbal modification involving adjectives, such as *hızlı* 'fast/quick', which differ from adverbs like *hızlıca* ('fast/quickly') in lacking the morpheme that derives adverbs from adjectives (e.g., *-ca*). These adjectives, known as 'non-derived adverbs,' cannot precede case-marked arguments and thus directly precede the verb (in the broad focus configuration), as shown in (65a). In contrast, with PI'ed arguments, these non-derived adverbs must still precede the PI'ed argument, as demonstrated in (65b) (Taylan 1984, Aydemir 2004, Öztürk 2005, Kamali 2015, Sağ 2022).¹⁹

- (65) a. *Ali [*hızlı] kitab-ı [hızlı] oku-du.
 Ali fast book-ACC fast read-PST

¹⁹ We could not find a similar discrepancy in adverbial modification in Laz.

- ‘Ali read the book fast.’ ✓ [NP-ACC [[fast] V]]
- b. Ali [hızlı] kitap [*hızlı] oku-du.
 Ali fast book fast read-PST
 ‘Ali did fast book-reading.’ ✓ [fast [[PI’ed NP] V]]

We interpret the disparity between derived and non-derived adverbs as indicative of the distinction between event kind and token domains in adverbial modification. Specifically, derived adverbs, such as *hızlıca* ‘fast/quickly,’ modify the event token-level denotation of a VP, whereas non-derived adverbs modify at the event kind level. We view non-derived adverbs as performing a restrictive function on (sub-)event kinds, operating post event-kind level argumentation.²⁰ For example, modifying the property of the book-reading event kind with *hızlı* (‘fast/quick’) results in a sub-kind of this event kind, i.e., fast book-reading, distinct from slow book-reading. As this modification occurs at the event kind level, canonical arguments are introduced above it, thereby explaining why case-marked arguments cannot be preceded by non-derived adverbs.²¹

In conclusion, distinguishing between event kind and event token-level denotations of the VP aligns effectively with the two types of adverbial modification observed in Turkish.

3.2.2 UTAH and Two Domains of Argumentation

By adopting a two-layered event domain approach, which corresponds to a two-layered argument structure, we are now poised to tackle the apparent violation of UTAH in clauses with agent PI.

We argue that UTAH operates autonomously within the event token domain, irrespective of the argumentation within the event kind domain. In simpler terms, arguments inside the VP have no bearing on the argumentation occurring outside the VP when UTAH compliance is concerned. As a result, the fact that the theme argument is introduced above the agent argument in clauses with agent PI does not pose a challenge to this principle. Take, for instance, the structure of *Ali-yi köpek ısırdı* ‘Ali got dog-bitten,’ in (56) above. Here, the agent NP *köpek* ‘dog’ undergoes PI within the VP as part of the event kind-level argumentation. The theme NP *Ali* is introduced outside the VP as part of the event token-level argumentation. UTAH is applicable in the event token domain independently of the event kind domain. Since there is no agent argument positioned below the theme argument above the VP, it is not violated in the event token domain.

While we have cross-linguistic evidence that UTAH holds in the event token domain (see Baker 1988, 1997), there remains both a technical and empirical question as to whether it also extends to the event kind domain. In our view, the canonical theme and agent arguments of a transitive clause without PI are both introduced at the level of event tokens VP-externally, as illustrated in (54) above. This provides the basis for testing the applicability of UTAH in this domain. On the other hand, a PI’ed NP is introduced as a complement to the complex V head, and as there is only one complement slot, argumentation within the VP is limited to one argument, as discussed above. This poses a challenge when testing whether UTAH applies in this domain.

Let us tentatively assume that UTAH compliance is checked independently in the event kind domain, in addition to being checked in the event token domain. Then, in the case of PI, ensuring UTAH compliance in the former enforces a specific formulation of this principle. Baker’s (1988, 1997) version implies that particular thematic roles have distinct, designated positions in the syntactic structure. In this view, an agent NP cannot be a complement to a verb, thus a PI’ed agent introduced in the VP-internal domain would violate UTAH even though it is not c-commanded by a theme NP in this domain. On the contrary, other scholars defend a ‘relativized’ version of UTAH, where it does not matter in what syntactic position the arguments are introduced as long as the hierarchy among the thematic roles is preserved. For instance, Larson (1988, 1990) proposes the following thematic hierarchy (see also Grimshaw 1990, Belletti and Rizzi 1988, Speas 1990, Li 1990):²²

²⁰ See also Sağ (2019, 2022) for evidence supporting the analysis of non-derived adverbs as event kind level modifiers, particularly in relation to a comparison of PI’ed arguments with bare plurals.

²¹ For an illustration of event kind-level modification in clauses with agent PI, consider example (19a). The contrast in (19) clearly shows that when the agent NP precedes the non-derived adverb (*fena* ‘bad’), it cannot be interpreted as a PI’ed argument. However, it is worth noting that non-derived adverbial modification is extremely limited with agent PI, as pointed out by a reviewer (e.g., not possible with *hızlı* ‘fast’). We leave the exploration of the reasons for this to future research.

²² As a reviewer rightly points out, in the present neo-Davidsonian context, Larson’s exact formulation cannot be adopted, since thematic arguments are no longer introduced by the verb. What matters, however, is the essence of Larson’s proposal,

(66) Thematic Hierarchy

Agent > Theme > Goal > Obliques (manner, location, time, ...)

If a verb α determines θ roles $\theta_1, \theta_2, \dots, \theta_n$, then the lowest role on the Thematic Hierarchy is assigned to the lowest argument in constituent structure, the next lowest role to the next lowest argument, and so on. (Larson 1988: 382)

If we adopt a relativized view of UTAH similar to Larson’s (66) and assume that it is checked independently in the event kind and event token domains, then UTAH is technically never violated at the level of event kinds, since only one argument is introduced VP-internally. More precisely, in clauses with agent PI, the VP-internal domain contains only the PI’ed agent NP, with no theme NP asymmetrically c-commanding it in this domain —hence, the hierarchy is preserved.

Needless to say, an important question remains: Is there any *empirical* motivation to assume that UTAH also applies in the event kind domain? Languages like Turkish and Laz cannot provide an answer, for they only allow PI of one argument per clause. Thus, addressing this question would require investigating languages that potentially allow multiple arguments to undergo PI within the same clause.²³

To summarize, if UTAH is checked only in the event token domain, agent PI presents no problem under any formulation of the principle. However, if it also applies independently in the event kind domain, whether a violation arises depends on which version of UTAH is adopted. That said, given the lack of evidence from Turkish and Laz that UTAH is enforced in the event kind domain, our proposal does not require commitment to any particular formulation. Rather, our goal has been to show that, despite the surface reversal of the thematic hierarchy, clauses with agent PI do not necessarily pose a challenge to UTAH within our system.

With this background in hand, we are ready to begin our theoretical investigation of the issues raised by agent PI concerning the case and agreement patterns in Turkish and Laz.

4 Agent Pseudo-incorporation and the Case and Agreement Puzzle

Under the two-layered verbal structure approach, clauses with agent PI result in an intransitive structure in the VP-external domain. In other words, there is only one argument above the VP: the theme NP. This renders the VP-external structure of clauses with agent PI identical to the one of unaccusatives, as schematized below:

(67) a. Agent PI

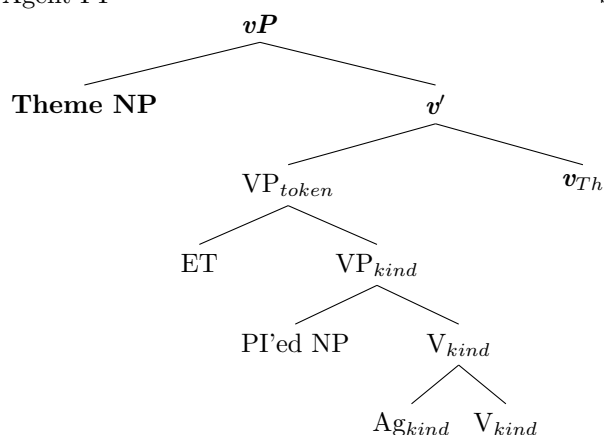

b. Unaccusatives

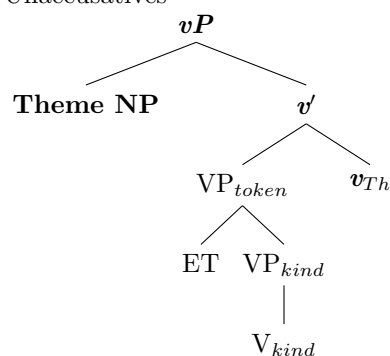

which ties UTAH to asymmetric c-command (i.e., a thematic hierarchy) rather than to designated positions of arguments within the structure.

²³ Another fruitful line of inquiry for finding answers to this empirical question could be investigating the viability of a thematic hierarchy in compounds (Jonathan Bobaljik, p.c.). Compounds like *apple-picking* in English have often been considered alongside noun incorporation in the literature due to their shared semantic characteristics. For example, just like incorporated nouns, the noun *apple* in *apple-picking* yields a number neutral interpretation. The prevailing intuition is that incorporation and compounding are grammatically different manifestations of a single semantic phenomenon. See, for instance, Harley (2012) who provides an account that aligns with Baker’s (1988) head-incorporation analysis, treating compounding as a form of syntactic incorporation within the framework of Distributed Morphology (Halle and Marantz 1993). We conjecture that all forms of incorporation, be it head-incorporation or PI, as well as their compounding alternates, serve the common purpose of establishing the taxonomy of event kinds, and they all involve argumentation at the event kind level.

Contrary to our predictions, we observe two indicators of transitive syntax emerging in clauses with agent PI: accusative case-marking on the theme NP in Turkish and object ϕ -agreement with the theme argument in Laz, as first shown in (3b) and (8a), which are repeated below in (68a) and (69a) respectively. As seen in (68b), the theme argument of an unaccusative form surfaces in the null nominative case in Turkish, and as seen in (69b), the prefixal agreement with an unaccusative verb is realized as *v-set* subject agreement in Laz, not *m-set* object agreement, in contrast to the pattern of agent PI.

- (68) Turkish
- a. Ali-**yi** köpek ısır-dı.
 Ali-ACC dog bite-PST
 ‘Ali got dog-bitten.’ agent PI
- b. Ali(***-yi**) düşt-ü.
 Ali-ACC fall-PST
 ‘Ali fell.’ unaccusative
- (69) Laz
- a. Ham oruba-s ma mtuti **m**’-ç’op-um-s.
 this river-LOC 1.SG bear 1.OBJ-catch-IMPF-PRS.3SG
 ‘In this river, I’d get bear-caught.’ agent PI
- b. **b**-ğurur, ***m**-ğurur
 1.SBJ-die.IMPF, 1.OBJ-die.IMPF
 ‘I am dying.’ unaccusative

Within the analysis adopted here, the patterns identified in Turkish and Laz raise a non-trivial challenge for theories of case and agreement. To elucidate our underlying assumptions, we will delve into this puzzle from the perspective of dependent-theoretic accounts of accusative case and object agreement.

4.1 Accusative Case and Agent PI

There are two prominent views on how morphological case is determined, which both build on earlier proposals in the generative tradition. One view, often called the classical Chomskyan view, takes case to reflect a dependency between a head and an NP (cf. Vergnaud [1977] 2008). Under a more recent incarnation of this approach, case is assigned by a functional head to the most local NP under agreement, i.e. via the abstract relation (Agree) that holds between the two (Chomsky 2000, 2001). In particular, the T head is responsible for assigning nominative case, while accusative case is assigned by the agent introducing little *v* head. In contrast, the alternative view, the initial articulation of which can be attributed to Marantz (1991), argues that case can be a morphological reflex of a dependency between NPs. From this perspective, the case marking an NP receives depends on the presence of a second NP, which has not yet been marked for case in the same local domain (e.g., Bittner and Hale 1996, Baker and Vinokurova 2010, Baker 2015, Kornfilt and Preminger 2015, Levin and Preminger 2015, Bárány and Sheehan 2015; cf. Yip et al 1987).²⁴ For convenience, we adopt the dependent-case determination algorithm presented in Baker and Vinokurova (2010) (B&V, henceforth) as its main empirical focus, i.e. the case distribution in the Turkic language Sakha, is parallel to that of Turkish. In what follows, we will provide a brief overview of their account and subsequently discuss the implications for agent PI within our system.

4.1.1 The Dependent Case Theory

B&V’s analysis classifies accusative and dative case as *dependent case*, while positing that nominative (and genitive) case is assigned through the interaction with a functional category, the T (and D) head, via Agree.²⁵

²⁴ Among these, Baker and Vinokurova (2010) stands out, presenting a synthesis of the functional and configurational perspectives. As it is orthogonal to our discussion, we do not take a stance on whether nominative can be analyzed as the morphological interpretation of caselessness, as argued in Kornfilt and Preminger (2015), Levin and Preminger (2015), or reflects a case assigned under agreement via T, as argued in Baker and Vinokurova (2010).

²⁵ As exemplified in (4a), the subject of a nominalized embedded clause receives the genitive case, irrespective of whether there is a single or multiple NPs in the clause. Consequently, the genitive could arguably be the unmarked case within nominal

B&V's Dependent Case Theory (DCT) draws on the following rules for dative and accusative case assignment (Baker and Vinokurova 2010: 595).

- (70) a. If there are two distinct argumental NPs in the same VP-phase such that NP1 c-commands NP2, then value the case feature of NP1 as *dative* unless NP2 has already been marked for case.
 b. If there are two distinct argumental NPs in the same phase such that NP1 c-commands NP2, then value the case feature of NP2 as *accusative* unless NP1 has already been marked for case.

This account, adopting the Chomskyan notion of phases, makes use of two phases: VP and CP. It is assumed that the dative case is assigned within the VP phase, while the accusative case is assigned within the CP phase. Let us illustrate how dative and accusative case assignment happens via the example in (71), the structure of which is assumed as sketched in (72).

- (71) Ali Merve-ye kitab-ı ver-di.
 Ali Merve-DAT book-ACC give-PST
 'Ali gave the book to Merve.'

- (72) a. [_{VP} Ali [_{VP} Merve-DAT [book give]] v]
 b. [_{VP} Ali [_{VP} **book**-ACC [_{VP} Merve-DAT [t give]]] v]

The goal and the theme NPs are base-generated inside the VP, as shown in (72a). The theme NP is merged as the complement of the V head while the goal NP is merged in spec, VP. A crucial assumption in B&V's account is that the rule in (70a) takes precedence over the rule in (70b).²⁶ Therefore, the goal NP is marked with dative case given that there are two NPs within the VP phase, with the goal NP as the c-commanding one. The application of (70a) bleeds the application of the rule in (70b) within the VP phase since the NP1 has already been marked for case. As a result, the theme NP remains caseless in the VP phase.

Subsequently, the theme NP needs to undergo movement outside the VP to be interpreted as a referential (i.e., definite) expression, as illustrated in (72b). According to Chomsky's (2000, 2001) Phase Impenetrability Condition (PIC), an NP can only move out of a phase and become part of a higher phase after moving to the edge of the lower phase. Therefore, the theme NP lands at the edge of the VP, becoming visible in the CP phase, and consequently, is assigned dependent accusative case, as it is c-commanded by the agent NP within this phase.²⁷

For completeness, let us also mention that B&V argue that if the theme NP remains within the VP, it is interpreted non-referentially (i.e., undergoes PI) and receives no case. Having nothing like a Case Filter, the caselessness of the VP-internal theme NP is legitimate under this theory.

4.1.2 The Dependent Case Theory and Agent PI

We will now consider the DCT within the system that we adopted in Section 3.1 and discuss the problems raised by clauses with agent PI. Given that our primary focus is on accusative case assignment, we will temporarily set aside the discussion of dative case.²⁸ To illustrate how accusative case is assigned in our system then, let us reconsider the canonical transitive clause that we have analyzed above as follows:

- (73) a. Ali **kitab-ı** oku-du.
 Ali book-ACC read-PAST
 'Ali read the book.'

domains. Alternatively, it could be a head-assigned case, in particular a case assigned under agreement with a D head. We do not take a stance on this as it is orthogonal to our point here. See Baker and Vinokurova (2010) for the latter view, and Levin and Preminger (2015) for a reply.

²⁶ This is because (70a) is more specific, only applicable in the VP phase, while (70b) applies to any phase. Alternatively, it could be stipulated that there is an extrinsic ordering that prioritizes (70a) over (70b).

²⁷ The word order in (71) could be derived from a subsequent movement of the dative-marked NP above the accusative-marked theme argument.

²⁸ We will integrate dative case assignment into our system in Section 7.

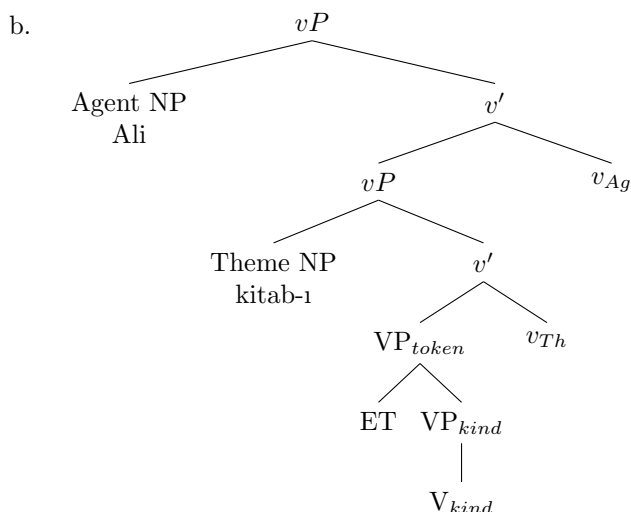

As stated above, the rule in (70b) mandates the presence of a c-commanding NP for the theme NP to be marked with accusative case, and these two NPs must maintain this hierarchical relation within the same phase. Recall that in B&V's system, the theme NP starts as a complement to the verb and escapes the VP phase by moving to the edge of the VP, where it becomes visible in the CP phase. In order to transfer the core of this idea to our system, let us, for now, assume that $v_{Th}P$ is the phase that corresponds to B&V's VP phase in our system. The theme NP, occupying the specifier position of $v_{Th}P$, is visible in the CP phase. Consequently, according to the rule in (70b), the theme NP, as the lower of the two NPs, is marked with accusative case.

Returning to our central puzzle, when the agent NP is PI'ed inside the VP, the hierarchical relation between the two NPs is reversed. As demonstrated in (74b), the agent argument now occupies a lower position than the theme NP. Consequently, we do not anticipate the theme argument to be marked with accusative case. Instead, we anticipate dative case on the theme NP and no case on the PI'ed agent NP as per the rule in (70a). This is because in B&V's system, dative case assignment precedes accusative case assignment, and both the theme and the PI'ed agent are in the same $v_{Th}P$ phase (VP phase in B&V's system). However, this prediction is not borne out.

- (74) a. Ali-yi köpek ısır-dı.
 Ali-ACC dog bite-PST
 'Ali got dog-bitten.'

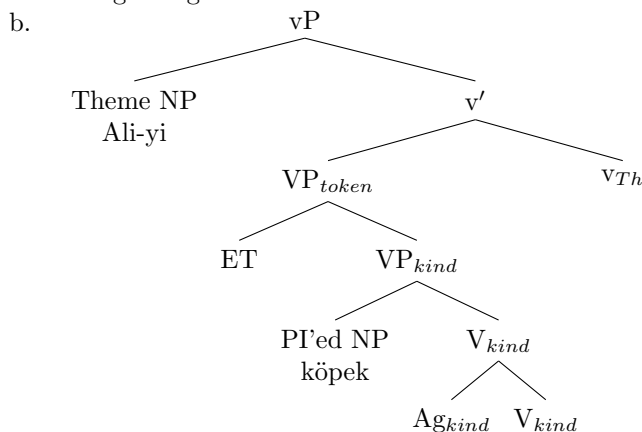

One immediate solution that comes to mind, which we cannot adopt under our semantic account of PI, is to assume that the PI'ed agent is merged later than the theme (with a structure similar to (73b)), resulting in the theme NP being marked as accusative (see Dikmen et al 2023 for such a solution). However, under this approach, the theme NP needs to undergo obligatory movement above the agent NP, but there is no

independent motivation for this. Such a movement would nevertheless be crucial in that the agent NP can only be understood as PI'ed if the theme precedes the agent as in (74a).

Another important challenge arises in implementing the movement-based view, as discussed in Dikmen et al (2023). If one assumes, for example, that the theme NP and the PI'ed agent are both introduced in the VP-internal domain (e.g., the theme as a complement of the V and the agent in the specifier of V), in B&V's system, the dative case rule in (70a) takes precedence. Consequently, the PI'ed agent would be marked dative and leaving the theme NP unmarked for case in this phase. Even if there is a way to bypass the dative case assignment rule, allowing the accusative rule to apply directly (see Dikmen et al 2023), this solution introduces yet another problem. We predict that the theme NP will bear the dependent accusative case regardless of whether it is PI'ed or not. That is, if the agent and theme arguments are base-generated in the VP-internal domain, the dependent case relation will also be established when the theme NP is PI'ed.

As discussed in Section 3.1, the semantics of PI necessitates the introduction of event kind-level arguments before event token-level arguments. In a compositional semantic approach, this means that the PI'ed agent should merge with the verb before any other canonical argument is introduced. Setting aside the case-related problems discussed above, adopting the theme-movement approach would imply that the VP-internal base position of the theme has no impact on meaning composition. However, there is no compelling rationale to merge an event token-level argument with the event-kind denoting verb before incorporating an event kind-level argument, only to subsequently move it out of the event-kind level domain.

An anonymous reviewer suggests that the theme-movement analysis might be feasible if the VP-internal trace of the moved NP is interpreted as a kind variable, while the moved NP denotes at the object level.²⁹ Assuming this is possible, we would expect a similar outcome to the PI of multiple arguments. The trace of the moved theme NP would be interpreted as part of the event kind, alongside the PI'ed agent. Since the domain of event kinds technically permits multiple arguments in this view, it should also be possible to not move the theme argument, allowing both the agent and the theme to be PI'ed as arguments of the event-kind denoted by the verb. However, as shown in Section 3.1, the simultaneous PI of these arguments is not observed in Turkish and Laz, and thus adopting this approach would leave these problems unresolved, besides failing to accommodate the predicted but unattested case-assignment patterns discussed above.

Given these problems, our initial move towards the analysis is to take VP_{token} as a distinct phase. This choice ensures that the PI'ed agent remains impervious to dependent case assignment (whether dative or accusative), regardless of any further structural assumptions. With only one argument slot inside the VP_{token} , no dependencies emerge, resulting in the caseless status of the VP-internal domain. As a result, our system will assume two phases: VP_{token} and CP phases.

To conclude, when we adhere to the order of argument introduction parallel to meaning composition, the issue of accusative case marking on the theme NP in clauses with agent PI remains a challenge that needs to be addressed in our analysis.

4.2 ϕ -Agreement with Objects and Agent PI

Our primary puzzle arises from a discrepancy between the theoretical stance we adopt regarding PI and the observed empirical facts: the VP-external intransitive structure in clauses with agent PI posited by our analysis is at odds with the morphological indicators of transitivity attested in these clauses. We have discussed this discrepancy through accusative case-marking on the theme NP in Turkish. In Laz, however, the indicator of transitivity becomes evident through ϕ -agreement patterns. To be able to delve into this further, we will first briefly examine how the agreement mechanism operates in Laz in the following section.

²⁹ The reviewer further suggests that the modificational restrictions on PI'ed arguments could be due to the size and attachment site of certain modifiers, and that ill-formed modifiers, having high attachment in the NP, may cause the NP to become too "big" for PI, necessitating its movement above the Event Tokenizer. Indeed, Sağ's distinction between taxonomic and object-level modification has been shown to correlate with the attachment site of modifiers in Martin (2022). Martin argues that kind-level modifiers merge lower (closer to the noun) compared to object-level modifiers. While the size issue could be compatible with a movement-based analysis, it is equally plausible to argue that object-level modifiers must always be merged above the Event Tokenizer in the VP-external domain. Therefore, modificational restrictions do not serve as a distinguishing diagnostic between movement-based analyses and our view that a PI'ed argument is base-generated lower than canonical arguments.

4.2.1 *Dependent ϕ -Agreement in Laz*

ϕ -agreement in Laz is realized in prefixal and suffixal slots on the verb. This paper does not delve into suffixal number and person agreement, which are largely tangential to the core puzzle. For relevant discussion, see Atlamaz (2013), Demirok (2013), Blix (2021) and Bondarenko and Zompì (2023). Our focus will be on the prefixal agreement slot, which differs from suffixal agreement in being invariant to tense and hosts one of the two sets of person agreement markers known as *m-set* and *v-set* markers. The agreement realization in the prefixal slot has a preference for participant (1st and 2nd person) objects, which are realized through *m-set* markers, as in (75). Otherwise, it employs *v-set* markers for subjects, as in (76). This agreement realization hierarchy can be seen, for instance, in *g-* for 2nd person object winning over *b-* for 1st person subject.

<p>(75) <i>m-set</i> agreement</p> <p>a. m- dzir -am -s 1.OBJ- see -IMPF -PRS.3SG.SUBJ ‘S/he sees me.’</p> <p>b. g- dzir -am -\emptyset 2.OBJ- see -IMPF -PRS(.1/2.SG.SUBJ) ‘I see you.’</p>	<p>(76) <i>v-set</i> agreement</p> <p>a. b- dzir -am -\emptyset 1.SUBJ- see -IMPF -PRS(.1/2.SG.SUBJ) ‘I see him/her/it.’</p> <p>b. \emptyset- dzir -am -\emptyset 2.SUBJ- see -IMPF -PRS(.1/2.SG.SUBJ) ‘You see him/her/it.’</p>
---	--

The prefixal agreement in Laz has been analyzed within a dependent-theoretic approach to agreement in Bondarenko and Zompì (2023) (B&Z, henceforth). In their view, the agent introducing little *v* head is the probe, which is insatiable in the sense that it agrees with all the NPs it can see. Assuming that Agree proceeds both downward and in a Spec-Head configuration, B&Z propose that the probe searches for a goal within its complement first and then its specifier (Béjar and Rezac 2009). Furthermore, *v* only interacts with participant NPs and copies the entire ϕ -features of the NP. Under the assumption that 1st and 2nd persons include the [participant] feature while 3rd person lacks it, then *v* only interacts with 1st and 2nd persons and cannot copy the features of 3rd person.

Crucially, the copied features are organized within a hierarchical structure, creating a complex *v* head, with later-copied bundles being head-adjoined higher than those copied earlier. For instance, in cases where *v* agrees with two NPs, the resulting hierarchy will have ϕ_1 representing the features from the first NP that *v* interacted with, and ϕ_2 representing the features from the second NP. These feature bundles are organized as illustrated in (77a). When *v* agrees with one NP, then the complex *v* structure involves only the feature bundle of that NP, as demonstrated in (77b) (B&Z: 13).



Drawing from insights in dependent case theories, B&Z analyze the feature bundle adjoined to *v* as *dependent* if it is c-commanded by another feature bundle adjoined to *v*. In contrast, a c-commanding feature bundle in the two NP structure or the sole feature bundle in the one NP structure is considered *unmarked*. In (77a), ϕ_1 is dependent and ϕ_2 is unmarked, whereas in (77b), the only feature bundle ϕ is unmarked. Additionally, the dependent ϕ -feature bundles take precedence over unmarked ϕ -feature bundles during the spell-out process, as only one of them can be accommodated in the prefixal slot.

To provide a more concrete illustration, the agreement paradigm presented in (77a) aligns with the pattern observed in (75), where the prefixal slot is occupied by the spell-out of the dependent feature bundle, i.e., *m-set* markers. Agreement with participant objects is then realized as **dependent agreement**.

The *v-set* agreement pattern in (76) is also derived from (77a) as follows: As stated above, *v* is unable to copy the features of 3rd-person NPs. Nevertheless, these unsuccessful attempts to agree with 3rd-person NPs are still represented within the structure as an empty (i.e., null) set of ϕ -features. Crucially, the spell-out of

dependent features is contingent on them having a non-empty (i.e., non-null) set of ϕ -features. Therefore, in (76), although ϕ_1 corresponds to 3rd person, dependent agreement does not arise due to ϕ_1 being an empty set. Consequently, the prefixal slot is spelled out by the unmarked ϕ_2 corresponding to the participant subject NP through *v-set* markers.

Single-argument verbs, namely unaccusatives and unergatives, exclusively manifest *v-set* agreement, as exemplified in (78). In simpler terms, when it comes to ϕ -agreement, single-argument verbs and transitive verbs with a non-participant (3rd person) object are equivalent.

- (78) *v-set* agreement
- a. **b-ğurur**, ***m-ğurur**
 1.SBJ-die.IMPF, 1.OBJ-die.IMPF
 ‘I am dying.’ unaccusative
- b. **v-igzal**, ***m-igzal**
 1.SBJ-walk.IMPF, 1.OBJ-walk.IMPF
 ‘I am walking.’ unergative

The complex *v* structure in (77b) represents the pattern observed in (78), under the assumption that the probe is the highest thematic argument introducing head, which is v_{Th} in unaccusatives and v_{Ag} in unergative constructions.³⁰ Since there is only one NP goal, which the probe finds in its specifier in both cases, only unmarked agreement arises in the prefixal slot, realized through *v-set* markers.

To simplify the discussion thus far, we summarize the prefixal agreement pattern in Laz as follows:

- (79) a. dependent agreement = *m-set* markers (realizes the non-null ϕ -feature bundle iff it is c-commanded by a second ϕ -feature bundle.)
 b. unmarked agreement = *v-set* markers (elsewhere) (after Bondarenko and Zompì 2023)

We are now ready to discuss the agreement puzzle posited in clauses with agent PI.

4.2.2 Dependent ϕ -Agreement and Agent PI

In clauses with agent PI, we expect the prefixal agreement slot to host *v-set* markers, aligning with the agreement pattern observed with single-argument verbs. To illustrate this, let us consider the structure of the clause in (80a) within B&Z’s analysis. (We do not show the locative adjunct in the structure.)

- (80) a. Ham oruba-s ma mtuti **m’-ç’op-um-s**.
 this river-LOC 1.SG bear 1.OBJ-catch-IMP-PRS.3SG
 ‘In this river, I’d get bear-caught.’

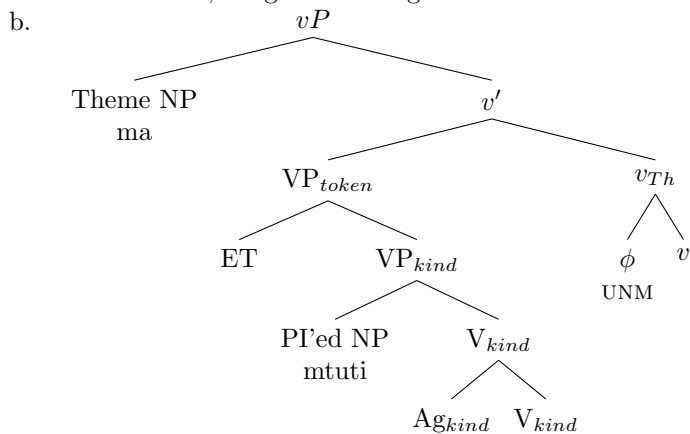

As proposed in Section 4.1.2, VP_{token} is a phase. Therefore, its complement is expected not to be visible to the probing *v*. Consequently, since there is only one NP goal, which the probe finds in its specifier (spec,

³⁰ B&Z assume that *v* (corresponding to our v_{Ag}) still projects in unaccusative structures and hence the probe in unergative and unaccusative constructions is the same in their analysis. However, both approaches predict *v-set* agreement.

$v_{Th}P$), only the feature bundle of this NP is copied under the probe. As no dependency arises, the prefixal slot is predicted to be spelled-out by the unmarked v -set agreement marker.

However, in clauses with agent PI, agreement with the theme NP in the prefixal slot is realized by dependent m -set markers, showing that the theme NP still counts as an object. Within B&Z's account of ϕ -agreement that we adopt, the availability of m -set agreement markers for the theme NP suggests the existence of a second, higher NP in the structure that is visible to the probe, as illustrated below.

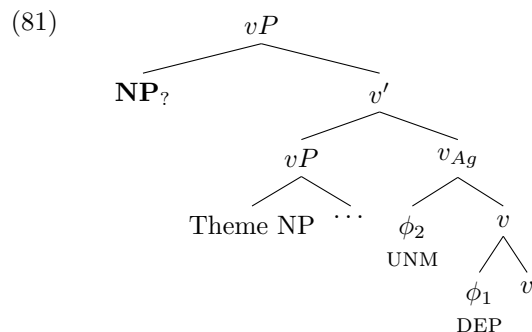

If the $NP?$ in (81) is the PI'ed agent itself, how do adjacency requirement, the caselessness requirement, and the underlying semantic considerations fit into the picture?

To zoom out, we must address two challenges in clauses with agent PI: the matter of accusative case marking on the theme NP in Turkish and the issue of m -set object agreement with the theme NP in Laz. Both puzzles indicate an NP that c -commands the theme NP for the dependent case and agreement patterns to manifest. Below, we demonstrate that adopting a fairly conservative syntax for incorporation is nevertheless possible. In particular, we argue that this c -commanding NP is not the PI'ed agent but an anchor pronoun.

5 The Analysis

In this section, we present our analysis to derive the transitive characteristics of a verbal structure involving agent PI. We propose that when an agent NP is PI'ed in the event kind domain VP-internally, a null pronoun occupies the canonical position of an agent argument, i.e., specifier of $v_{Ag}P$ in the event token domain. This is illustrated in (82):

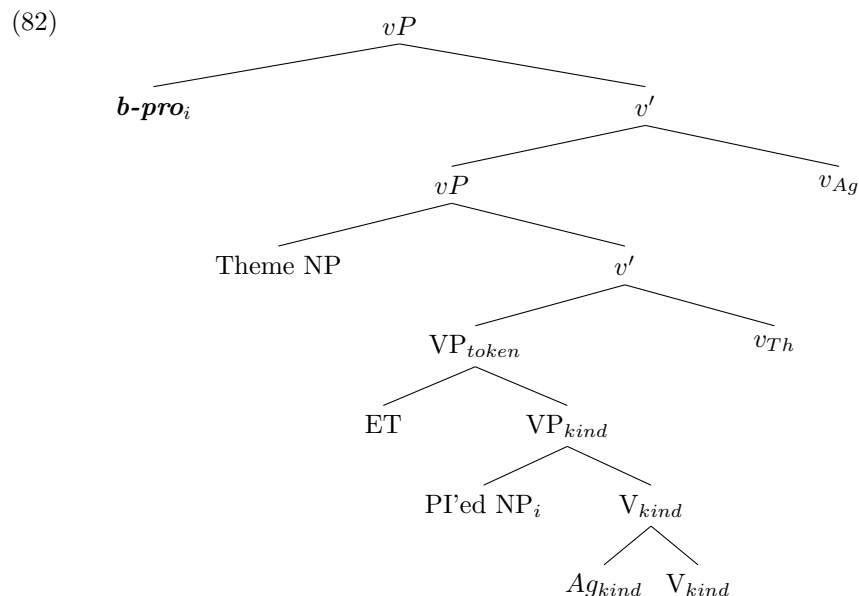

It is crucial to note that this pronoun resembles expletive pronouns in serving as a syntactic placeholder, as it occupies the canonical position of a thematic argument merged lower in the structure to undergo PI. However, we analyze it as a category with semantic content, and thus it is not an expletive in the traditional sense, which are assumed to be semantically vacuous and inserted solely to satisfy syntactic requirements. More precisely, we argue that the motivation behind the merge of our anchor *pro* lies in the need to establish the *belong-to* relation between the PI'ed singular kind introduced as a thematic argument at the event kind domain and the object-level members of this kind that hold the corresponding thematic relation in the event token domain. We will henceforth label it as *b-pro*, with the prefix *b-* indicating its role in mediating the *belong-to* relation, as already represented in (82) above.

Recall that in Sağ's (2024) analysis, ET type-shifting comes with an entailment, pertaining to the thematic arguments in the event token domain. This is posited as the Event Tokenization axiom, repeated in (83).

$$(83) \quad \textbf{Event Tokenization}$$

$$\forall e_k, x_k, \theta_k [\theta_k(e_k) = x_k \rightarrow [\forall e, \theta_t [\textit{belong-to}(e, e_k) \wedge \textit{correspond-to}(\theta_t, \theta_k)] \rightarrow \exists y [\textit{belong-to}(y, x_k) \wedge \theta_t(e) = y]]]$$

For example, take (84), the clause with agent PI in Turkish that we have been discussing so far. Ali's involvement in the *dog-bite* event kind —the event kind whose agent is the dog kind —entails the existence of one or more dogs that *belong to* the dog kind as the agent of a biting event token.

$$(84) \quad \text{Ali-} \mathbf{y\ddot{i}} \quad \text{köpek ısırdı.}$$

Ali-ACC dog bite-PST
'Ali got dog-bitten.'

We propose that the establishment of the *belong-to* relation between the PI'ed singular kind and its object-level members is not merely an entailment that holds at the conceptual level due to (83), but is *also* grammatically encoded —achieved via the presence of *b-pro*. More precisely, in Sağ (2024), Event Tokenization is introduced as an independent semantic condition on PI, specifying what it means to be involved in an event token of an event kind. In the present analysis, we reflect the effects of this axiom within the compositional machinery of the grammar: *b-pro* functions as the syntactic and semantic anchor for the object-level entities that stand in the *belong-to* relation to the PI'ed kind.³¹ In what follows, we detail our assumptions about the semantics of *b-pro* and the syntactic rules that govern its distribution.

Starting with the semantics of *b-pro*, we rely on the notion of index to model the co-dependence between *b-pro* and the PI'ed NP. Specifically, we take singular kinds to be associated with an index *i*. For example, assuming that the dog kind has the index 3, the bare singular *köpek* involves this information in its denotation —through *iota* type-shifting, it refers to the unique dog kind which is equal to $g(3)$ —as illustrated below:

$$(85) \quad \iota([\textit{köpek}_{k,3}]) = \iota x_k [\textit{dog}_k(x_k) \wedge x_k = g(3)] = \text{DOG}_3$$

The anchor *b-pro*, embedding the index *i* of the PI'ed singular kind term in its semantics, takes an argument of type $\langle e, \langle v, t \rangle \rangle$ (i.e., the denotation of its sister, v') and returns an event property of type $\langle v, t \rangle$ and forms a *belong-to* relation between the kind with index *i* and its object-level members by introducing a local \exists -closure:³²

$$(86) \quad [[b\text{-}pro_i]] = \lambda Q_{\langle e, \langle v, t \rangle \rangle} . \lambda e. \exists y [\textit{belong-to}(y, g(i)) \wedge Q(y)(e)]$$

³¹ In XXX, we initially analyzed the null pronoun as a true expletive devoid of semantic content, basing its merge on an EPP-like requirement of the probing v_{Ag} . However, this account requires that v_{Ag} still be merged in the structure, even though it does not introduce a thematic argument. While this leaves the implications for semantic composition unclear, in such an account, the semantic function we assign to *b-pro* could be maintained as an independent condition (83) that needs to be satisfied at the conceptual level, as originally proposed in Sağ (2024). Nonetheless, the analysis presented here is advantageous: it provides an independent rationale for the merge of v_{Ag} , motivated by the necessity to introduce a thematic agent argument in the event token domain, even when the agent NP undergoes PI in the event kind domain. This reduces theoretical stipulation and yields a more explanatory and compositionally transparent account of agent PI.

³² One might question whether the *b-pro* analysis would lead to a Condition C violation, as pointed out by a reviewer. We would like to highlight that the index is part of *b-pro*'s semantics and does not correspond to what the pronoun itself refers to. The referent of the index (i.e., a singular kind) participates in some sort of possessive (i.e., *belong-to*) relation within the existential interpretation of *b-pro*. That is, the structure of a clause with agent PI is analogous to *His_i father kissed the boy_i*, which does not trigger a Condition C violation in either English or Turkish —unlike *He_i kissed the boy_i*.

Based on this, the denotation of (84) is composed as illustrated below:

- (87) a. $\llbracket \text{VP}_{kind} \rrbracket = \lambda e_k [\text{bite}_k(e_k) \wedge \text{Ag}_k(e_k) = \iota x_k [\text{dog}_k(x_k) \wedge x_k = g(3)]]$
 (PI structure: the property of the *biting* event kind whose agent is the *dog* kind)
- b. $\llbracket \text{VP}_{token} \rrbracket = \lambda e. \exists e_k [\text{belong-to}(e, e_k) \wedge [\text{bite}_k(e_k) \wedge \text{Ag}_k(e_k) = \iota x_k [\text{dog}_k(x_k) \wedge x_k = g(3)]]]$
 (The property of event tokens that belong to the *dog-bite* event kind)
- c. $\llbracket [{}_{vP} \text{Ali} [{}_{vP} \text{VP}_{token} v_{Th}]] \rrbracket = \lambda e. \exists e_k [\text{belong-to}(e, e_k) \wedge [\text{bite}_k(e_k) \wedge \text{Ag}_k(e_k) = \iota x_k [\text{dog}_k(x_k) \wedge x_k = g(3)]] \wedge \text{Th}_t(e) = \text{Ali}]$
 (Ali, the theme of the event token, is introduced.)
- d. $\llbracket [{}_{v'} [{}_{vP} \text{Ali} [{}_{vP} \text{VP}_{token} v_{Th}]] v_{Ag} \rrbracket = \lambda x. \lambda e. \exists e_k [\text{belong-to}(e, e_k) \wedge [\text{bite}_k(e_k) \wedge \text{Ag}_k(e_k) = \iota x_k [\text{dog}_k(x_k) \wedge x_k = g(3)]] \wedge \text{Th}_t(e) = \text{Ali} \wedge \text{Ag}_t(e) = x]$
 (The event token-level Agent thematic function is introduced.)
- e. $\llbracket [{}_{vP} \mathbf{b-pro}_3 [{}_{v'} [{}_{vP} \text{Ali} [{}_{vP} \text{VP}_{token} v_{Th}]] v_{Ag}]] \rrbracket = \lambda e. \exists y [\text{belong-to}(y, g(3)) \wedge \exists e_k [\text{belong-to}(e, e_k) \wedge [\text{bite}_k(e_k) \wedge \text{Ag}_k(e_k) = \iota x_k [\text{dog}_k(x_k) \wedge x_k = g(3)]] \wedge \text{Th}_t(e) = \text{Ali} \wedge \text{Ag}_t(e) = y]]]$
 (*b-pro* establishes the *belong-to* relation between the dog kind and its object-level members, the agent of the biting event token.)

Our motivation to analyze singular kinds associated with an index stems from their ability to behave like anaphoric definites, as shown in (88) for Turkish (example from Despić 2019: 282, see also Schoenfeld 2023).

- (88) Kel kartal Kuzey Amerika-da bul-un-ur. Güç ve hız-ın sembol-ü olarak
 bald eagle north America-LOC find-PASS-AOR strength and speed-GEN symbol-3SGPOSS as
 tam-n-ır. Ancak küresel ısınma nedeniyle, **kuş** yakında tamamen
 recognize-PASS-AOR however global warming because bird soon completely
 yok ol-abil-ir.
 disappear-ABIL-AOR
 ‘The bald eagle is found in North America. It’s the symbol of strength and speed. However, because
 of the global warming, the bird may soon completely disappear.’
 OK if *kuş* ‘bird’ is anteceded by *kel kartal* ‘bald eagle’

In (88), the bare singular *kuş* ‘bird’ shown in bold refers to the bald eagle kind introduced in the first sentence. This shows that singular kind terms can be anaphoric definites, which we take to bear an index in their denotation, in the sense of Schwarz’s (2009) work on German ‘strong’ definites. Intriguingly, plural kind terms do not have this type of anaphoric behavior as evidenced by the inability of *kuş-lar* ‘birds’ in (89) to be anteceded by *kel kartal-lar* ‘bald eagles’ introduced in the first sentence (Despić 2019: 282). Instead, for this interpretation, the bare plural needs to be preceded by a demonstrative, e.g., *bu kuş-lar* ‘these birds,’ which would be the bearer of the index. While *kuş* ‘bird’ can also be accompanied by a demonstrative in (88), its ability to be an anaphoric definite without a demonstrative, in contrast to the plural kind in (89), shows that singular kind terms bear an index in their semantics.³³

- (89) Kel kartal-lar Kuzey Amerika-da bul-un-ur-lar. Güç ve hız-ın sembol-ü
 bald eagle-PL north America-LOC find-PASS-AOR-3PL strength and speed-GEN symbol-3SGPOSS
 olarak tam-n-ır-lar. Ancak küresel ısınma nedeniyle, **kuş-lar** yakında tamamen
 as recognize-PASS-AOR-3PL however global warming because bird-PL soon completely
 yok ol-abil-ir.
 disappear-ABIL-AOR
 ‘Bald eagles are found in North America. They are the symbol of strength and speed. However,
 because of the global warming, birds may soon completely disappear.’
 * if *kuş-lar* ‘birds’ is anteceded by *kel kartal-lar* ‘bald eagles’, OK with *bu kuş-lar* ‘these birds’

³³ As mentioned in fn 11, Sağ (2022) shows that bare plurals cannot undergo PI in Turkish. The lack of index on plural kind terms could be the reason for this. That is, *b-pro* needs to be coindexed with the index of the PI’ed kind term in the event token domain to be able to establish the relation between the PI’ed kind and the object-level entities associated with it, as formalized in (93) below. PI of plural kind terms might be at odds with this requirement due to the lack of an index associated with them.

The contrast in anaphoric definiteness between singular and plural kind terms is also observed in Laz kind terms, as exemplified below (*zerdava*: a dog breed native to the Black Sea region of Turkey and Georgia):

- (90) a. Zerdava Lazona-s i-dzir-en, msk'vanoba do nosi-şi simboli
 Zerdava.NOM Lazona-LOC PASS-see-IMPF.PRS.3SG beauty and wisdom-of symbol
 on. Ama globaluri mçxvapa-şen laç'i viti-eçi ts'ana-şk'ule soti var
 be.PRS.3SG but global hotness-ABL dog.NOM ten-twenty year-after anywhere NEG
 sk'ud-asen.
 live-FUT.3SG
 'The zerdava is found in Lazona. It's the symbol of beauty and wisdom. However, because of
 the global warming, the dog won't be found anywhere in ten to twenty years.'
 OK if *laç'i* 'dog' is anteceded by *zerdava* 'the zerdava'
- b. Zerdavape Lazonas idziren, msk'vanoba do nosişi simboli oran. Ama globaluri mçxvapaşen
 *(ham) laç'epe viti-eçi ts'anaşk'ule soti var sk'udanen.
 'Zerdavas are found in Lazona. They are the symbol of beauty and wisdom. However, because
 of the global warming, these dogs won't be found anywhere in ten to twenty years.'
 * if *laç'-epe* 'dogs' is anteceded by *zerdava-pe* 'zerdavas,' OK with *ham laç'-epe* 'these dogs'

The establishment of the *belong-to* relation via local \exists -closure accounts for both the number neutrality and the narrow scope property of the PI'ed NP, aligning with insights from Sağ (2022, 2024).³⁴ More specifically, *b-pro* is an $\langle\langle e, \langle v, t \rangle \rangle, \langle v, t \rangle\rangle$ type expression, involving an \exists -quantification that integrates into the event predication. Since all scope-taking elements are interpreted above the existential closure of the event variable, the quantification introduced by *b-pro* is constrained to a narrow scope relative to these elements. Canonical quantifiers, which are of type $\langle\langle e, t \rangle, t\rangle$, undergo Quantifier Raising (QR) to resolve the classical type mismatch problem, where thematic functions require an *e* type argument. In contrast, *b-pro*, due to its type, cannot and does not need to undergo QR. Should QR occur, *b-pro* must reconstruct to its original position to avoid a type mismatch at the landing site—where the sister node is of type $\langle e, t \rangle$ through λ -abstraction but *b-pro* remains a $\langle\langle e, \langle v, t \rangle \rangle, \langle v, t \rangle\rangle$ type. Consequently, even if *b-pro* c-commands a quantifier in its base position, the subsequent QR of the quantifier will ensure that *b-pro* is always interpreted under the scope of this quantifier.³⁵

We now turn to the syntactic rules ensuring the desired distribution of *b-pro* in the structure. There are three configurations that we need to prevent from being generated. First, *b-pro* must be prohibited

³⁴ The \exists -quantification supplied by *b-pro* implies that PI'ed arguments introduce discourse referents. The anaphoric potential of incorporated arguments remains a debated topic; however, Seidel (2019) has experimentally demonstrated that Turkish PI'ed nouns introduce discourse referents, with their anaphoric uptake influenced by factors such as predicate type and the 'affectedness' of the PI'ed argument within the event. Similar findings have been reported for Persian in Modarresi (2014) and Krifka and Modarresi (2016), as well as for Hungarian in Farkas and De Swart (2003). Although the factors influencing the anaphoric uptake of PI'ed arguments differ across these languages, each of these studies supports analyses that involve low existential quantification, aligning with our perspective. We conjecture that the complexities of anaphoricity associated with PI may stem from the dual introduction of discourse referents—both at the event kind and token levels. This dual introduction could complicate the processing, particularly when a subsequent pronoun must choose between two types of discourse referents associated with the PI'ed noun, with certain factors potentially aiding in resolving this problem.

³⁵ Our view of local \exists -closure is similar to Chierchia's (1998, 2023) solution to the narrow scope interpretation of bare plurals in English, exemplified by sentences like 'Dogs are not barking today.' In his earlier framework, bare plurals are analyzed as kind-denoting expressions which, when combined with object-level predicates, undergo Derived Kind Predication (DKP). DKP resolves the type mismatch by applying local (i.e., event-level) \exists -closure to the instances of the kind, yielding a narrow scope interpretation for the bare plural. In more recent work, however, Chierchia (2023) revises his earlier account, proposing that kind-denoting expressions can serve as direct arguments to object-level predicates, while still allowing object-level instances of those kinds to be introduced via local \exists -closure. Specifically, when a plural kind is a thematic argument of an event, as illustrated in (i), instances of that kind are simultaneously introduced as thematic arguments of its sub-events—a mechanism that reflects, in the grammar, an axiom on plural kind argumentation (i.e., exemplification). This dual representation accounts for examples like (ii), in which bare plurals introduce object-level discourse referents.

- (i) a. Birds are chirping.
 b. $\exists e [Ag_w(e) = \cap birds \wedge \exists y[\cup \cap birds_w(y) \wedge \exists e'[e' \leq e \wedge Ag_w(e') = y \wedge chirp_w(e') \wedge chirp_w(e)]]]$
- (ii) This morning, dugongs_i were letting themselves_i die, because they were trapped.

Our analysis is similar in spirit, offering a blend of Sağ's (2022) and (2024) analyses of PI semantics.

from involving an index distinct from that of the PI'ed kind term. In such a scenario, *b-pro* would simply operate on a kind different from the referent of the singular kind term PI'ed lower in the event kind domain. However, this configuration should be ruled out, as it would conflict with the tokenization of the event kind whose singular kind argument must have object-level members bearing the corresponding thematic role in the event token domain, in accordance with (83). In essence, for the composition to yield a semantically coherent result, *b-pro* needs to be coindexed with the PI'ed singular kind term.

Second, in the case of PI, introducing a thematic argument other than *b-pro* in the event token domain must be ruled out. If the syntax allowed the introduction of a different thematic argument in this domain, agent-doubling constructions, as in (91), would be expected to be well-formed. However, this results in an ill-formed structure.³⁶

- (91) *Karabaş Ali-yi köpek ısır-dı.
 Karabaş Ali-ACC dog bite-PST
 Intended: ‘Ali got dog-bitten by Karabaş.’

Third, *b-pro* cannot be inserted in the event token domain to yield a reading akin to agent PI unless a PI'ed agent is introduced in the event kind domain. This is shown in (92), which cannot be interpreted as “Ali got dog-bitten.”

Context: The dog₃ is a dangerous animal.

- (92) **b-pro*₃ Ali-yi ısır-dı.
 Ali-ACC bite-PST
 Intended: ‘Ali got dog-bitten.’

To prevent these configurations, we propose the Argument Correspondence Principle, as shown in (93), which ensures that a PI'ed argument introduced in the event kind domain and its anchor *b-pro* in the event token domain are co-dependent and bear the same index. Argument Correspondence should be understood as a set of explicit syntactic rules that enforce, within the grammar, the conceptual requirement that an event-kind-level argument must stand in a *belong-to* relation with its object-level members in the event token domain, as encapsulated by the Event Tokenization axiom.³⁷

(93) **Argument Correspondence**

Let *b-pro* be an anchor argument that mediates between the event kind and event token domains.

- a. If an argument NP is introduced by a θ_k head in the event kind domain, the corresponding θ_t head in the event token domain must introduce *b-pro* as its argument.
- b. If *b-pro* is introduced as the argument of a θ_t head in the event token domain, there must be a corresponding θ_k head in the event kind domain introducing an NP argument.
- c. *b-pro* and the NP introduced by the θ_k head must be associated with the same index.

Finally, let us consider what we gain from the *b-pro*-based analysis of PI. Our proposal allows us to address the dependent case and agreement patterns in Turkish and Laz that were discussed in the previous section. Essentially, the presence of an anchor pronoun in the specifier of $v_{Ag}P$ enables us to retain a transitive structure above the VP when the agent undergoes PI lower inside the VP. This, in turn, allows us to explain the fact that, under agent PI, the theme NP in Turkish is subject to dependent accusative case assignment. Given that *b-pro* and the theme NP are in the same CP phase, the theme NP being *c*-commanded by *b-pro* receives accusative case marking. Our analysis also explains that the theme NP in Laz continues to trigger *dependent* agreement through *m-set* markers. This follows from the fact that the probe v_{Ag} finds

³⁶ In Section 7, we extend the *b-pro* analysis to theme PI. When this extension is taken into account, the restriction on doubling contrasts with what has been reported for some other languages, such as Chamorro, where argument doubling is attested in clauses with theme PI. While such languages require further consideration within our account, Chung and Ladusaw (2004) argue that the additional theme argument in Chamorro is syntactically an adjunct. On this view, theme doubling in incorporation structures may ultimately be compatible with our analysis.

³⁷ We are grateful to an anonymous reviewer for suggesting this line of analysis. While we remain agnostic about how these syntactic rules should be formally modeled, the co-dependence and co-indexation between the PI'ed NP and *b-pro* suggest that an operation such as Agree/Checking could plausibly underlie these relations (e.g., see Bjorkman and Zeijlstra 2019).

both the theme NP via downward-probing (i.e., in its complement) and the *b-pro* in upward-probing (i.e. in its specifier) and realizes the first set of ϕ -features it finds using dependent *m-set* markers.

As a concluding note, while our analysis suggests a null category to account for the case and agreement patterns, there are languages where an overt expletive, which presumably lacks thematic content, results in accusative case assignment on a lower NP. The German existential construction with *es gibt* serves as an example of this phenomenon, where the expletive *es* is accompanied by an accusative-marked object NP, as illustrated below (McFadden 2004: 193):

- (94) Es gibt einen Fußballgott.
 it gives a football-god.ACC
 ‘There is a god of football.’

McFadden (2004) argues that *es* in these constructions is introduced in the specifier of *vP* (*v_{Ag}P* in our analysis), aligning more closely with weather expletives than true expletives. According to McFadden, accusative case assignment depends on the existence of a c-commanding DP in this position. Therefore, the non-thematic nature of the expletive is irrelevant for dependent case. While the potential semantic connections between the two await further research, our analysis then draws a parallel between PI and such expletive constructions in terms of dependent case assignment, albeit with a covert and a semantically contentful pronoun.³⁸

6 Further support

In this section, we discuss two predictive outcomes of our analysis, derived from the passivization patterns in Turkish and Laz as well as oblique subject constructions in Laz.

6.1 Passivization

Passivization affects case assignment in Turkish, aligning with the predictions of the DCT. The theme NP is precluded from receiving accusative case, as shown in (95b), in contrast to the active construction in (95a). This stems from the demotion of the c-commanding agent NP by passivization (Dikmen et al 2022: 1).

- (95) a. Korra biz-i kovala-dı.
 Korra 1.PL-ACC chase-PST
 ‘Korra chased us.’
 b. Biz (Korra tarafından) kovala-n-dı-k.
 1.PL Korra by chase-PASS-PAST-1PL
 ‘We were chased (by Korra).’

Turkish also permits passivization of single-argument verbs, yielding impersonal passive constructions with both unaccusative and unergative verbs (Dikmen et al 2022: 1):

- (96) a. Bu çukur-a düş-ül-ür.
 this hole-DAT fall-PASS-AOR
 ‘One may fall into this hole.’
 Lit. ‘It is fallen into this hole.’
 b. Dün maraton-da koş-ul-du.
 yesterday marathon-LOC run-PASS-PST
 ‘There was running in the marathon yesterday.’
 Lit. ‘It was run in the marathon yesterday.’

The facts are also similar in Laz. In a canonical passive form, the main morphosyntactic reflex of passivization is the pre-root vowel *i-* appearing on the verbal complex. Furthermore, agreement with the theme NP is no longer via *m-set* markers as the theme NP fails to trigger dependent agreement but exhibits unmarked agreement. Compare the passive construction in (97b) with the active construction in (97a).

³⁸ In their analysis of passives in Sakha, Baker and Vinokurova (2010) similarly account for the accusative case on the object NP that survives under passivization, by resorting to a null pronoun that existentially saturates the agent slot.

- (97) a. Ma **m-dzir-am-s**.
 1.SG 1.OBJ-see-IMPF-PRS.3SG.SUBJ
 ‘S/he is seeing me.’ active: dependent agreement with the theme NP
- b. Ma **v-i-dzir-er**.
 1.SG 1.SBJ-PASS-see-PASS.IMPF.PRS.NON3SG.SUBJ
 ‘I am being seen.’ passive: unmarked agreement with the theme NP

Impersonal passivization is also possible in Laz, as exemplified in (98), where the only argument of the unergative verb is demoted through passivization.

- (98) Germa-pe-s **i-k’i-en**.
 mountain-PL-LOC PASS-yell-PASS.IMPF.PRS.3SG
 ‘One screams in mountains.’
 Lit. ‘It is screamed in mountains.’

Drawing on the general perspective on the semantics of passivization in the literature, we take the passive markers on the verbal complexes of these languages to signal that the (highest) argument slot is existentially saturated (cf. Dikmen et al 2022 for Turkish and Taylan and Öztürk 2014, Eren 2021 for Laz).

Our analysis predicts that passivization should be unavailable in clauses with agent PI. This arises from the requirement for the highest argument slot to be occupied by the anchor *b-pro* to establish the *belong-to* relation between the PI’ed agent and its object-level members in the event token domain, as stated in (93a) of Argument Correspondence. This pronoun already existentially saturates the agent argument slot in the event token domain, playing a role similar to passivization in a sense. Therefore, the two cannot co-occur. Furthermore, omitting the *b-pro* in the specifier of v_{Ag} and instead existentially closing (i.e., demoting) the agent argument through the passive morpheme is ruled out because passivization does not form a *belong-to* relation between the PI’ed kind argument and its object-level members in the event token domain. This would violate Argument Correspondence and thus fail to implement the requirement imposed by Event Tokenization in the compositional system. Our prediction is borne out in both Turkish and Laz, as evidenced by the ungrammaticality of the following passivized clauses with agent PI:

- (99) a. *Burada ben köpek ısır-ıl-ır-ım.
 here 1.SG dog bite-PASS-AOR-1SG
 Intended: ‘Here, I would be dog-bitten.’ Turkish
- b. *ham oruba-s ma k’oncolozi v-i-ç’op-er
 this river-loc 1.SG koncolozi 1.SBJ-PASS-catch-PASS.IMPF
 Intended: ‘In this river, I would be *koncolozi*-caught.’ Laz
 (*koncolozi*: a witch-like creature in Anatolian folklore)

It is crucial to highlight that the unavailability of passivization in these constructions cannot be attributed to some sort of incompatibility of passivization with PI. While we discuss this in Section 7, it suffices to illustrate here that impersonal passivization in clauses with theme PI is possible in both languages:

- (100) Burada kitap oku-n-ur.
 here book read-PASS-AOR
 ‘One does book-reading here.’
 Lit. ‘It is done book-reading here.’ Turkish
- (101) Hak oxori d-i-dg-en.
 here house PV-PASS-put-PASS.IMPF.PRS.3SG
 ‘One does house-building here.’
 Lit. ‘It is done house-building here.’ Laz

Having demonstrated that our analysis accurately predicts the unavailability of passivization in clauses with agent PI, we shift our focus to oblique subject constructions in Laz in the following section.

6.2 Oblique Subject Constructions in Laz

Oblique subject constructions in Laz (also known as *inverse* constructions) feature an applicative (Appl) head that licenses a dative-marked agent NP. The theme NP, on the other hand, is realized in the null nominative form. The Appl head surfaces as a prefix on the verb and the prefixal agreement always tracks the dative-marked subject via *m-set* dependent agreement, as exemplified in (102) (Öztürk 2013).³⁹

- (102) Şk'u iri-s ham çitabi m-i-k'itx-ap-ur-an.
 we all-DAT this book.NOM 1.OBJ-1/2.APPL-read-CAUS-IMPF-3PL
 'We all have read this book before.'

Adopting the analysis proposed in Bondarenko and Zompì (2023), we take the structure of oblique subject constructions to be as illustrated in (103), where the agent NP is introduced in the specifier of the ApplP, which is embedded under the projection of some *v* head, hosting the probe.⁴⁰ We refer the reader to B&Z for the justification of particular assumptions in this structure. What is crucial for our purposes is that the external argument has to be introduced by an Appl head, which is lower than the probe in the structure. The form of the APPL prefix on the verb depends on the ϕ -features of the argument introduced in spec, ApplP, as evident in (102), where it is realized as *i-* for 1/2 person.

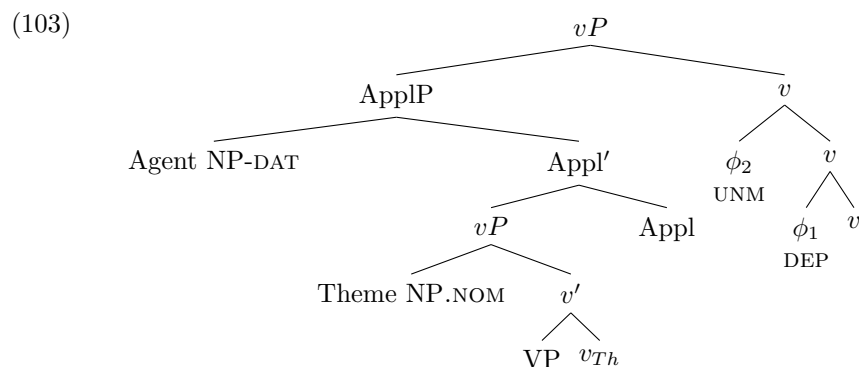

This structural alignment derives the desired agreement pattern as follows: The probe searches its complement, where there are two ϕ -feature bundles visible to the probe. The downward probing *v* first interacts with the ϕ -feature bundle of the agent NP and then the ϕ -feature bundle of the lower theme NP. Consequently, the copied features of the agent are c-commanded by the copied features of the theme under the probing head, which triggers dependent *m-set* agreement with the agent NP in oblique subject constructions.

It is essential to note that the analysis by B&Z, which generally addresses South Caucasian languages, predominantly discusses oblique subject constructions from the perspective of Georgian. However, Georgian differs from Laz in one crucial aspect regarding these constructions. In Georgian, if the agent argument is a 3rd person NP and the theme argument is a 1/2 person NP, the prefixal agreement manifests as *v-set* unmarked agreement, reflecting the feature bundle of the theme NP, as illustrated in (104a). In Laz oblique subject constructions, by contrast, the ϕ -features of the theme NP cannot surface at all, as shown in (104b).

- (104) a. v-u-ki-var
 1.SUBJ-3.APPL-be.1
 '(S)he has praised me.' (Georgian, Aronson 1990: 272)
- b. Şana-s şk'u iri u-mskv-ap-un / *v-u-mskv-ap-ur-t
 Şana-DAT we all.NOM 3.APPL-praise-CAUS-IMPF.3SG / 1.SUBJ-3.APPL-praise-CAUS-IMPF-PL
 'Şana has praised us all before.'

³⁹ Laz exhibits omnivorous number agreement. If the probe successfully copies ϕ -features of the most local NP in its complement and/or the NP in its specifier, we will see the plural feature of either of the NPs being realized as suffixal plural agreement. This is how we observe the plural marking in (102). See Bondarenko and Zompì (2023) more on plural agreement in Laz.

⁴⁰ In that respect, the structure proposed in Bondarenko and Zompì (2023) differs from the ones proposed in Öztürk (2013), Demirok (2013). However, the difference is orthogonal to the discussion at hand. The point we want to make in this section is concerned with the presence of an ApplP projection, which all accounts agree on.

While we defer the explanation for this disparity between the two languages to future research, we tentatively propose that in this construction in Laz, the theme NP patterns like a 3rd person singular NP, with its ϕ -features unable to value the probe. This is not an unusual pattern across South Caucasian. In some non-standard dialects of Georgian, whenever there is a dative subject, this is done overtly by using the reflexive form of the pronoun to express the theme NP, as shown in (105a), a phenomenon that Harris (1981) terms ‘object camouflage’ (cf. with (105b)). Hence, we assume that the theme NP in these constructions in Laz is also covertly *camouflaged* into a third person singular NP, with its ϕ -features being invisible from outside.⁴¹

- (105) a. Baghv-s **chemitavi** u-q’var-s.
 child-DAT myself 3.APPL-love-PRS.3SG
 ‘The child loves me.’ (Non-standard Georgian, author fieldnotes)
- b. Bavshv-s (**me**) v-u-q’var-var.
 child-DAT 1.SG.NOM 1.SUB-3.APPL-love-BE.1
 ‘The child loves me.’ (Standard Georgian, author fieldnotes)

With this background in mind, we now turn to how oblique subject constructions lend support to our analysis. Crucially, oblique subjects can undergo PI, which is evidenced by the fact that the agent loses the dative marking and is immediately preverbal, as exemplified in (106). Notably, the verb is still inflected with the APPL prefix, which is realized in the 3rd person default form, *u-*.

- (106) Šk’u iri mzurzi n-u-*mts*x-ap-un.
 we all.NOM bee PV-3.APPL-sting-CAUS-IMPF.3SG
 ‘We all have got bee-stung before.’

Extending the logic of the argument thus far, we propose that a null anchor pronoun, i.e., *b-pro*, is merged in spec-AppIP when agent PI occurs in oblique subject constructions. This results in the structure demonstrated in (107).

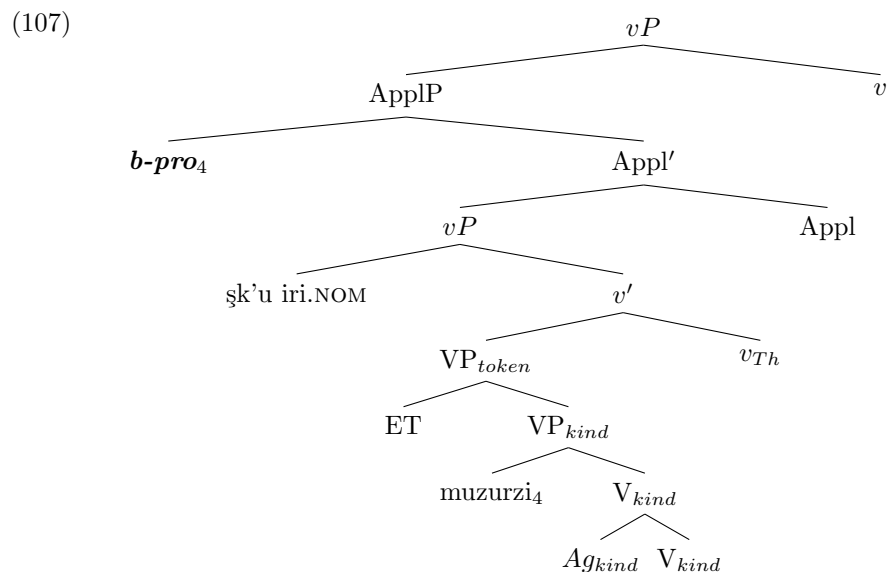

In the presence of *b-pro*, occupying spec, AppIP, we do not expect a prefixal agreement marker on the verb, since *b-pro* is in the 3rd person and is the first NP that the probe encounters. Crucially, in the event-token domain, argumentation takes place as usual, with *b-pro* occupying the spec of AppIP. The APPL prefix that surfaces on the verb, being realized in the 3rd person default form, substantiates this point.

In summary, the absence of passivization in clauses with agent PI in Turkish and Laz, along with the overt applicative marker surfacing in oblique subject constructions with agent PI in Laz, supports the claim

⁴¹ Demirok (2013) provides an alternative PIC-based account of the invisibility of the theme NP to the probe in these constructions. We leave a comparison to future work.

that a null pronoun occupies the specifier of the canonical position of an agent argument (spec, $v_{Ag}P$ or ApplP) when the agent NP undergoes PI within the VP-internal domain.

7 Extending the Analysis to Theme Pseudo-incorporation

The motivation behind positing a null pronoun as the anchor of the PI'ed agent in the VP-external domain is grounded in the semantics of PI we adopted here. To reiterate, the role of *b-pro* is to establish a *belong-to* relation between the singular kind argument introduced in the event kind domain and the object-level entities associated with this kind, maintaining the same thematic role in the event token domain. By existentially saturating the argument slot of the agent introducing thematic function in the event token domain, *b-pro* functions as a bridge between the two domains of events. This logic naturally extends beyond the incorporation of the agent argument and should be applicable to clauses with PI in general. Therefore, in this section, we extend the analysis to PI of theme arguments and argue that when the theme NP undergoes PI in the event kind domain within the VP, the specifier of $v_{Th}P$ is likewise occupied by the null *b-pro*. We then discuss the consequences of this move for passivization and dependent dative case assignment.

Let us illustrate our point with the structure of (108a), a clause with theme PI in Turkish, illustrated in (116). The denotation of (108a) is given in (108b).

- (108) a. Ali kitap oku-du.
 Ali book read-PST
 ‘Ali did book-reading.’
 b. $\exists e. \exists y [belong\text{-}to(y, g(2)) \wedge \exists e_k [belong\text{-}to(e, e_k) \wedge [read_k(e_k) \wedge Th_k(e_k) = \iota x_k [book_k(x_k) \wedge x_k = g(2)]] \wedge Th_t(e) = y \wedge Ag_t(e) = Ali]]$
 c.

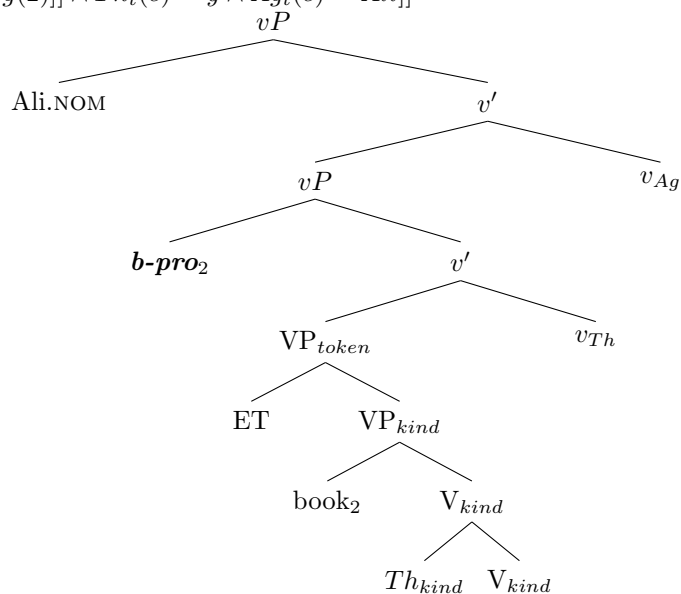

In a nutshell, the anchor *b-pro*, merged in the specifier of $v_{Th}P$, is coindexed with the PI'ed singular kind term bearing the theme role in the event kind domain and introduces a local \exists -closure over the members of the singular kind, which hold the theme role in the event token domain.

An immediate consequence of our analysis emerges in passivization of clauses with theme PI. We anticipate an interpretation on par with impersonal passivization because not only the agent argument is demoted through existential saturation via passivization but also the theme argument slot of the event token is existentially saturated by *b-pro*. As evidenced by the examples in (100) and (101), this prediction is borne out in both Turkish and Laz. We repeat the example for Turkish below:

- (109) Burada kitap oku-n-ur.
 here book read-PASS-AOR

‘One does book-reading here.’
 Lit. ‘It is done book-reading here.’

One other consequence of extending the null *b-pro* to clauses with theme PI concerns dependent dative case assignment in Turkish. Recall that in Baker and Vinokurova’s (2010) account, the DCT also extends to dative case assignment, as illustrated in the dependent case assignment rules repeated below (Baker and Vinokurova 2010: 595):

- (110) a. If there are two distinct argumental NPs in the same VP-phase such that NP1 c-commands NP2, then value the case feature of NP1 as *dative* unless NP2 has already been marked for case.
 b. If there are two distinct argumental NPs in the same phase such that NP1 c-commands NP2, then value the case feature of NP2 as *accusative* unless NP1 has already been marked for case.

In an example such as (111), B&V take the goal and theme NPs to be in the VP phase, where the goal NP, c-commanding the theme NP, is marked dative due to the rule in (110a) being more specific than (110b) (see fn 18, though).

- (111) Ali Merve-ye kitab-ı ver-di.
 Ali Merve-DAT book-ACC give-PST
 ‘Ali gave the book to Merve.’

The strongest support for the claim that dative is a dependent case in Turkish comes from the causativization of intransitive and transitive constructions, as illustrated in the contrast below, which we first introduced in (6). As a reminder, when an intransitive verb is causativized, the causee receives accusative marking, but when a transitive verb is causativized the causee receives dative case marking. This shows that the causee is marked dative only if it c-commands another NP in the structure.

- (112) a. Sevgi Ali-**yi** koş-tur-du.
 Sevgi Ali-ACC run-CAUS-PST
 ‘Sevgi made Ali run.’ causativized intransitive
 b. Sevgi Ali-**ye** kitab-ı oku-t-tu.
 Sevgi Ali-DAT book-ACC read-CAUS-PST
 ‘Sevgi made Ali read the book.’ causativized transitive

We will now illustrate how dependent dative case patterns are derived in our system.

The semantics of PI we adopt here suggests a mapping to two-layered alignment of verbal structure: PI occurs VP-internally, a domain that is opaque to case assignment, and canonical argumentation occurs in the VP-external domain, where case assignment is operative. Aligning with this structure, our system employs two distinct phases: the VP_{token} phase and the CP phase.

We propose that the VP-external structure (the CP phase) nevertheless involves a total of two domains for each cycle of case assignment.⁴² The smallest domain is defined as the complement of the highest thematic argument in the structure. That is, in constructions involving $v_{Ag}P$ as the highest thematic projection, the complement of v_{Ag} is a case domain. If this domain involves two NPs then, the higher one is marked dative and the lower one is unmarked for case. If the domain involves only one NP, no dependent case assignment takes place. When the highest thematic argument is merged, the smaller domain of case assignment is still visible, and therefore the lower NP that remained unmarked for case in the previous cycle receives dependent accusative case. Based on this, we revise the dependent case assignment rules as follows:

- (113) Dependent Case Assignment
 a. If there are two distinct argumental NPs in the smallest case domain in the same phase —the complement of the highest thematic head —such that NP1 c-commands NP2, then value the case feature of NP1 as *dative* unless NP2 has already been marked for case.
 b. If there are two distinct argumental NPs in the same phase such that NP1 c-commands NP2, then value the case feature of NP2 as *accusative* unless NP1 has already been marked for case.

⁴² The notion of cycle we are entertaining here is comparable to the notion of *soft phase* in Baker (2014a).

In ditransitive and causative constructions, the projections of goal introducing and causee introducing heads are the smallest domains for case assignment. As a result, the goal NP and the causee NP (if a transitive verb is causativized) will be marked dative, since they are the higher NPs c-commanding the theme argument. When the agent/causer argument is merged, the agent/causer NP and the lower theme NP, which remained unmarked for case in the previous cycle, will enter into a dependency relation, resulting with the theme argument receiving accusative case. Below, we illustrate this for (112b), where the smallest case domain is shown in bold. The representation follows a bi-eventive analysis of Turkish causatives proposed by Akkuş (2021) (cf. Key 2013, Harley 2017, Nie 2020).

(114)

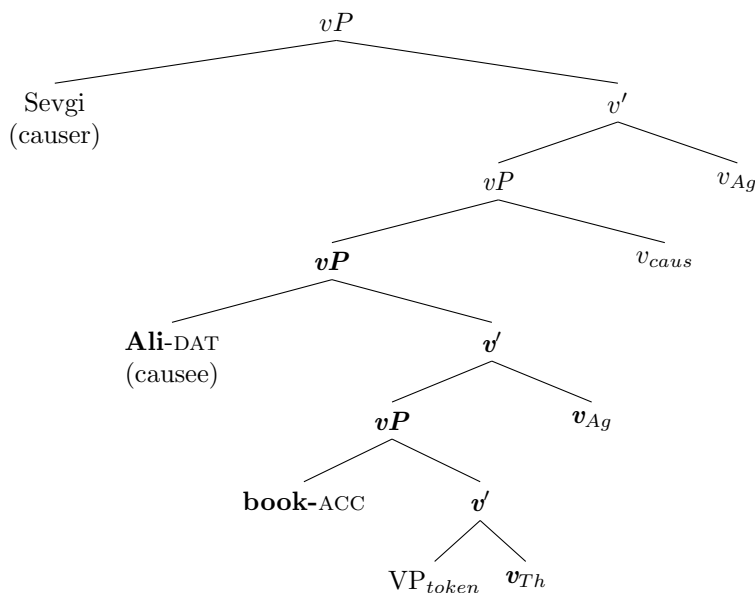

To complete the picture, when an intransitive verb is causativized (no v_{Th} projection), as in (112a), since the smallest case domain does not involve any other NP, the causee argument remains unmarked for case in the first cycle. With the merge of the causer NP though, it receives dependent accusative case in the second cycle of case assignment triggered within the larger case domain in the CP phase.

In causative constructions where the theme NP undergoes PI, the causee retains dative case marking, aligning with the causative structures with a canonical theme NP. The relevant example is repeated below:

- (115) Sevgi Ali-**ye**/*-**yi** kitap oku-t-tu.
 Sevgi Ali-DAT/*ACC book read-CAUS-PST
 ‘Sevgi made Ali do book-reading.’

causativized construction with PI

This pattern is correctly predicted in our analysis due to the null $b-pro$ occupying the specifier of $v_{Th}P$ when the theme NP undergoes PI in the VP-internal structure. That is, although the PI’ed theme NP is situated within the lower VP phase and hence cannot play a role in the case assignment mechanism in the VP-external domain, $b-pro$ as its anchor in this domain ensures that the c-commanding causee NP is marked with dependent dative case, as illustrated below. Otherwise, we would expect the causee to receive accusative case marking, similar to the pattern observed with the causativization of intransitive structures.

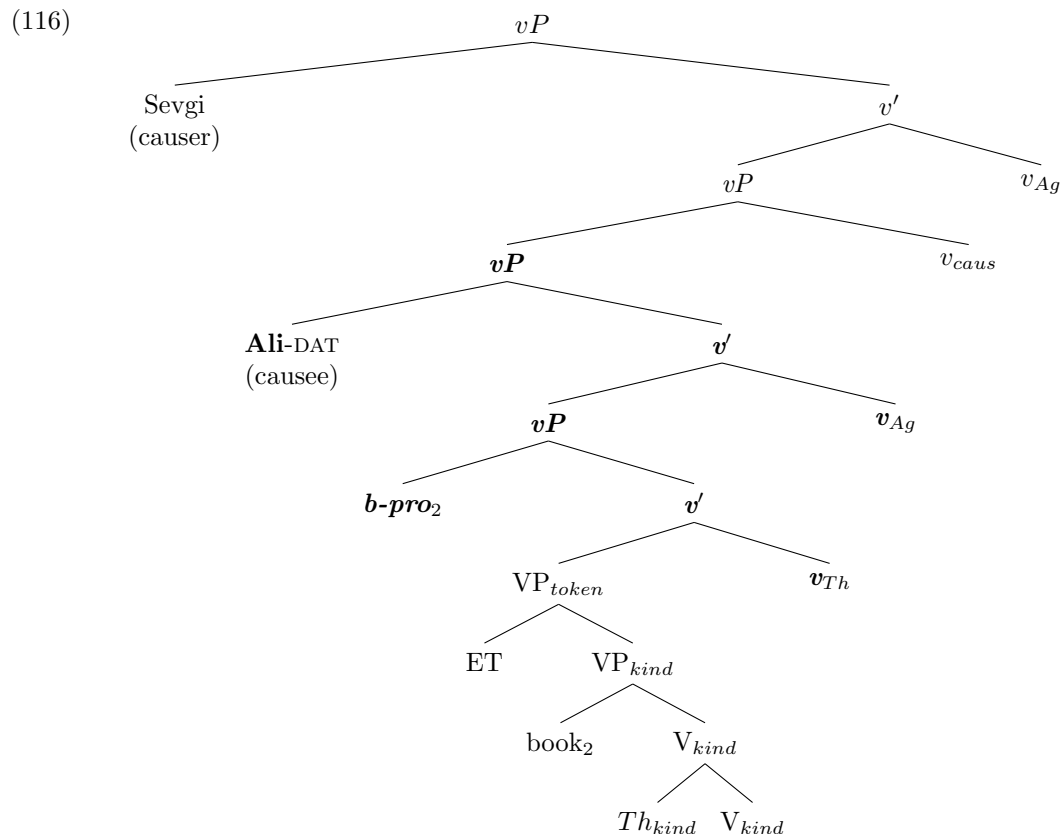

To summarize, the analysis we developed for explaining dependent case and agreement patterns in clauses with agent PI in Turkish and Laz also extends to PI of theme arguments. The null anchor pronoun view has proven instrumental in effectively deriving impersonal passivization in clauses with theme PI, as well as dependent dative case assignment patterns in ditransitive and causative constructions.

8 Concluding Remarks

In this paper, we have examined the syntax and semantics of pseudo-incorporation, focusing on the pseudo-incorporation of agent arguments in Turkish and Laz and its impact on dependent case and agreement patterns in these languages. Informed by the semantics of PI as an event kind-level argumentation process, we developed a unified model for both agent and theme PI. By adopting a two-layered structure for the event domain, we have illustrated how this configuration provides a coherent explanation for patterns of accusative case assignment and object agreement.

At the heart of our analysis is the proposal of a semantically contentful null pronoun occupying the canonical agent/theme argument position in the event token domain, serving as an anchor for the PI'd argument within the event kind domain. This null pronoun is pivotal for connecting argumentation across the event kind-level and event token-level verbal domains. Our approach not only deepens the understanding of PI but also sheds light on the nature of argument structure in general, particularly in relation to UTAH, which, we suggest, functions in the event token domain separately from the event kind domain. Additionally, our analysis extends to dependent dative case assignment in Turkish. Reconsidering dependent case assignment within a framework that derives observed patterns with arguments remaining in situ, we circumvent the need for potentially stipulative movement operations.

Looking ahead, our research paves the way for further exploration, particularly in relation to argumentation manifested through head-incorporation—a phenomenon, which, by impacting the valency of the verb and altering a transitive structure to an intransitive configuration, affects case marking, as we have seen in (1a). This pattern, distinct from the PI constructions we have analyzed, warrants additional investigation.

Specifically, it raises questions about whether and how argumentation in the event kind domain connects with the event token domain in languages featuring head-incorporation, akin to what we observe in clauses with PI. Given the valency-changing nature of head-incorporation, an initial conclusion might be that our anchor pronoun analysis does not readily extend to this phenomenon. However, further exploration is needed to understand how it fits with the semantic characteristics of incorporation as adopted in our current system.

Finally, we are left to ponder whether the two-layered argument structure we have outlined for Turkish and Laz also exists in languages that do not employ any form of incorporation. Should this be the case, the next step would be to investigate the cross-linguistic manifestations of the novel architecture we have proposed in this study.

References

- Aguilar-Guevara A, Zwarts J (2010) Weak definites and reference to kinds. In: Proceedings of SALT 20, pp 179–196
- Akkuş F (2021) (implicit) argument introduction, voice and causatives. Ph.d. thesis, University of Pennsylvania
- Anderson C, Morzycki M (2015) Degrees as kinds. *Natural Language and Linguistic Theory* 33(3):791–828
- Aronson HI (1990) *Georgian: A Reading Grammar*. Slavica, Columbus, OH
- Atlamaz U (2013) Cyclic agreement and empty slots in pazar laz. In: Proceedings of BLS37
- Aydemir Y (2004) Are Turkish preverbal bare nouns syntactic arguments? *Linguistic Inquiry* 35(3):465–474, URL <http://www.jstor.org/stable/4179286>
- Baker M (1988) *Incorporation: A Theory of Grammatical Function Changing*. University of Chicago Press, Chicago
- Baker M (2015) *Case: its principles and its parameters*. Cambridge University Press, Cambridge
- Baker MC (1997) *Thematic Roles and Syntactic Structure*, Springer Netherlands, Dordrecht, pp 73–137
- Baker MC (2014a) On dependent ergative case (in shipibo) and its derivation by phase. *Linguistic Inquiry* 45(3):341–379
- Baker MC (2014b) Pseudo Noun Incorporation as covert incorporation: linearization and crosslinguistic variation. *Language and Linguistics* 15:5–46
- Baker MC, Bobaljik J (2017) *On Inherent and Dependent Theories of Ergative Case*, Oxford, pp 111–134
- Baker MC, Vinokurova N (2010) Two modalities of case assignment: case in sakha 28:593–642, DOI <https://doi.org/10.1007/s11049-010-9105-1>
- Bale A, Khanjian H, Gagnon M (2010) Cross-linguistic representations of numerals and number marking. In: Proceedings of SALT 20, pp 1–15
- Barwise J, Perry J (1983) *Situations and Attitudes*. MIT Press, Cambridge, MA.
- Belletti A, Rizzi L (1988) Psych-verbs and -theory. *Natural Language & Linguistic Theory* 6(3):291–352
- Bittner M (1994) *Case, Scope, and Binding*, Springer Netherlands, Dordrecht, pp 1–48
- Bittner M, Hale K (1996) The structural determination of case and agreement. *Linguistic Inquiry* 27(1):1–68, URL <http://www.jstor.org/stable/4178925>
- Bjorkman BM, Zeijlstra H (2019) Checking up on (-)agree. *Linguistic Inquiry* 50(3):527–569, DOI 10.1162/ling.a.00319
- Bliss H (2004) The semantics of the bare noun in Turkish. In: Mezhevich I, Dobrovolsky MB (eds) *Calgary Papers in Linguistics*, vol 25, University of Calgary, pp 1–65
- Blix H (2021) Spans in South Caucasian agreement. *Natural Language Linguistic Theory* 39:1–55, DOI 10.1007/s11049-020-09475-x
- Bondarenko T, Zoppi S (2023) Leftover agreement. To appear in *Natural Language and Linguistic Theory*
- Bárány A, Sheehan M (2015) When dependent case is not enough. In: *GLOW 42*, Oslo
- Béjar S, Rezac M (2009) Cyclic Agree. *Linguistic Inquiry* 40(1):35–73, DOI 10.1162/ling.2009.40.1.35, URL <https://doi.org/10.1162/ling.2009.40.1.35>
- Carlson G (2006) The meaningful bounds of incorporation. In: Vogeleeer S, Tasmowski L (eds) *Non-definiteness and Plurality*, John Benjamins Publishing Company, pp 35–50
- Carlson G, Sussman RS (2005) Seemingly indefinite definites. In: *Linguistic Evidence: Empirical, Theoretical, and Computational Perspectives*, pp 26–30

- Carlson GN (1977) Reference to Kinds in English. PhD thesis, University of Massachusetts, Amherst
- Chierchia G (1998) Reference to Kinds across Language. *Natural Language Semantics* 6(4):339–405
- Chierchia G (2023) Kinds, properties and atelicity. In: *Proceedings of SALT 33*
- Chomsky N (2000) Minimalist inquiries: The framework. In: Roger Martin DM, Uriagereka J (eds) *Step by step: Essays on minimalist syntax in honor of Howard Lasnik*, MIT Press, Cambridge, pp 89–155
- Chomsky N (2001) Derivation by phase. In: Kenstowicz M (ed) *Ken Hale: a life in language*, MIT Press, Cambridge, pp 1–52
- Chung S, Ladusaw WA (2003) *Restriction and saturation*. The MIT Press, Cambridge, Massachusetts
- Chung S, Ladusaw WA (2004) *Restriction and Saturation*. MIT Press, Cambridge, Massachusetts
- Dayal V (2004) Number marking and indefiniteness in kind terms. *Linguistics and Philosophy* 27:393–450
- Dayal V (2011a) Hindi pseudo-incorporation. *Natural Language Linguistic Theory* 29(1):123–167
- Dayal V (2011b) Hindi pseudo-incorporation. *Natural Language and Linguistic Theory* 29(1):123–167, DOI 10.1007/s11049-011-9118-4
- Dayal V (2015) Incorporation: morpho-syntactic vs. semantic considerations. In: Borik O, Gehrke B (eds) *The Syntax and Semantics of Pseudo-Incorporation*, *Syntax and Semantics* 40.
- Demirok Ö (2013) *AGREE as a Unidirectional Operation: Evidence from Laz*, Unpublished M.A. thesis, Boğaziçi University
- Despić M (2019) On kinds and anaphoricity in languages without definite articles. In: Aguilar-Guevara A, Loyo JP, Vázquez-Rojas Maldonado V (eds) *Definiteness across languages*, *Language Science Press*, Berlin, pp 259–291
- Dikmen F, Demirok Ö, Öztürk B (2022) How can a language have double-passives but lack antipassives? *Glossa: a journal of general linguistics* 7(1)
- Dikmen F, Demirok Ö, Atlamaz Ü (2023) Revisiting agent pseudo-incorporation in Turkish: A dependent case theoretic perspective. *Linguistic Review*
- Eren Ö (2021) Fake arguments as apparent valency changers: Evidence from Laz. In: *Proceedings of WC-CFL38*
- Espinal MT, McNally L (2011) Bare nominals and incorporating verbs in Spanish and Catalan. *Journal of Linguistics* 47(1):87–128, DOI 10.1017/S0022226710000228
- Farkas D, De Swart H (2003) *The Semantics of Incorporation: From Argument Structure to Discourse Transparency*. CSLI Publications
- van Geenhoven V (1998) *Semantic Incorporation and Indefinite Descriptions: Semantic and Syntactic Aspects of Noun Incorporation in West Greenlandic*. *Dissertations in Linguistics*, CSLI Publications, URL https://books.google.com/books?id={_}QV9QgAACAAJ
- Gehrke B (2015) Adjectival participles, event kind modification and pseudo-incorporation. *Natural Language and Linguistic Theory* 33(3):897–938
- Gehrke B, McNally L (2011) Frequency adjectives and assertions about event types. In: Cormany E, Ito S, Lutz D (eds) *Proceedings of SALT 19*, pp 180–197
- Ginzburg J (2005) Situation Semantics: The ontological balance sheet. *Research on Language and Computation* 3.4:363–389
- Görgülü E (2012) *Semantics of Nouns and the Specification of Number in Turkish*. Ph.d. thesis, Simon Fraser University
- Gračanin-Yüksek M, İşsever S (2011) Movement of bare objects in Turkish. *Dilbilim Araştırmaları* 22(1):33–49
- Grimshaw J (1990) *Argument Structure*. MIT Press, Cambridge, MA
- Halle M, Marantz A (1993) *Distributed Morphology and the Pieces of Inflection*, MIT Press, Cambridge, pp 111–176
- Harley H (2012) Compounding in Distributed Morphology. In: Lieber R, Štekauer P (eds) *The Oxford Handbook of Compounding*, *Oxford Academic*
- Harley H (2017) The “bundling” hypothesis and the disparate functions of little *v*, *Oxford University Press*, Oxford
- Harris AC (1981) *Georgian syntax: a study in relational grammar*. Cambridge University Press, Cambridge
- von Heusinger K, Kornfilt J (2005) The case of the direct object in Turkish: Semantics, syntax and morphology. *Turkic languages* 9 pp 3–44

- Jo J, Palaz B (2022) Incorporating a nominal into a phrasal predicate: The case of agent, goal, and multi-nominal pseudo-incorporation in Turkish. *Linguistic Research* 39(3):431–465
- Johanson L (1977) Bestimmtheit und Mitteilungsperspektive im türkischen Satz. In: *Zeitschrift der Morgenlandischen Gesellschaft*, suppl. 3/2 edn, pp 1186–1203
- Kamali B (2015) Caseless direct objects in Turkish revisited. *ZAS Papers in Linguistics* 58 pp 107–123
- Key G (2013) The morphosyntax of the Turkish caustive construction. Ph.d. thesis, The University of Arizona
- Kornfilt J (1984) Case Marking, Agreement, and Empty Categories in Turkish. Ph.d. thesis, Harvard University
- Kornfilt J (1997) *Turkish*. Routledge, London
- Kornfilt J, Preminger O (2015) Nominative as no case at all: an argument from raising- to-accusative in Sakha. In: *Proceedings of the 9th workshop on Altaic formal linguistics*, vol. 76. 109., MITWPL
- Kratzer A (1998) More structural analogies between pronouns and tenses. In: *The Proceedings of Semantics and Linguistic Theory 8 (SALT 8)*
- Krifka M, Modarresi F (2016) Number neutrality and anaphoric update of pseudo-incorporated nominals in Persian (and weak definites in English). In: *Proceedings of SALT 26*, pp 874–891
- Krifka M, Pelletier F, Carlson G, ter Meulen A, Chierchia G, Link G (1995) Genericity: an introduction. In: Carlson G, Pelletier FJ (eds) *The Generic Book*, The University of Chicago Press, Chicago
- Landman F (1989) Groups, I. *Linguistics and Philosophy* 12(5):559–605
- Landman M, Morzycki M (2003) Event-kinds and the representation of manner. In: Antrim NM, Goodall G, Schulte-Nafeh M, Samiiian V (eds) *Proceedings of the Western Conference in Linguistics (WECOL) 2002*, California State University, Fresno
- Larson R (1988) On the double object construction. *Linguistic Inquiry* 19:335–392
- Larson R (1990) Double objects revisited: a reply to Jackendoff. *Linguistic Inquiry* 21:589–632
- Levin T, Preminger O (2015) Case in sakha: are two modalities really necessary? *Natural Language Linguistic Theory* 33(1):231–250, URL <http://www.jstor.org/stable/43697767>
- Li Y (1990) On v-v compounds in chinese. *Natural language & linguistic theory* 8(2)
- Luo Q (2022) Bare nouns, incorporation, and event kinds in mandarin chinese. *Journal of East Asian Linguistics* 31(2):221–263
- Marantz A (1991) Case and licensing. In: *Proceedings of ESCOL'91*
- Martin J (2022) Compositional routes to (non)intersectivity. PhD thesis, Harvard University
- Massam D (2001) Pseudo noun incorporation in niuean. *Natural Language Linguistic Theory* 19(1):153–197
- McFadden T (2004) *The Position of Morphological Case in the Derivation: A Study on the Syntax-Morphology Interface*. Ph.d. dissertation, University of Pennsylvania
- Mithun M (1984) The evolution of noun incorporation. *Language* 60(4):847–894
- Modarresi F (2014) Bare nouns in Persian: Interpretation, Grammar and Prosody. Ph.d. thesis, Humboldt Universität zu Berlin
- Nie Y (2020) Licensing arguments. Ph.d. thesis, New York University
- Öztürk B (2005) *Case, Referentiality, and Phrase Structure*. John Benjamins Publishing Company, Amsterdam
- Öztürk B (2009) Incorporating agents. *Lingua* 119(2):334–358
- Öztürk B (2013) Low, high and higher applicatives: evidence from Pazar Laz, John Benjamins Publishing Company, pp 275–296
- Öztürk B, Pöchtrager M (2011) Pazar Laz. *LINCOM*
- Sadock J (1980) Noun incorporation in Greenlandic: a case of syntactic word formation. *Language* 56:300–319
- Sağ Y (2018) The Semantics of Turkish Numeral Constructions. In: *Proceedings of Sinn und Bedeutung 22*
- Sağ Y (2022) Bare singulars and singularity in turkish. *Linguistics and Philosophy* 45(4):741–793
- Sağ Y (2024) Pseudo-incorporation, Event Kinds, and Atelicity, to appear in *Proceedings of Sinn und Bedeutung 29*
- Sağ Y (2019) The semantics of number marking: Reference to kinds, counting, and optional classifiers. PhD thesis, Rutgers University
- Sağ Y (2022) Bare singulars and singularity in turkish. *Linguistics and Philosophy* 45(4):741–793, DOI 10.1007/s10988-021-09323-0
- Schäfer R (2007) On frequency adjectives. In: Waldmuller EP (ed) *Proceedings of Sinn und Bedeutung 11*, Universitat Pompeu Fabra, Barcelona, pp 555–567

- Schoenfeld A (2023) Subkinds and anaphoricity: Avoid covert complexity. In: *Proceedings of Sinn und Bedeutung* 28 (to appear)
- Schwarz F (2009) Two Types of Definites in Natural Language Two Types of Definites in Natural Language. Ph.d. thesis, University of Massachusetts Amherst
- Schwarz F (2014) How weak and how definite are weak definites? In: Aguilar-Guevara A, Bruyn BL, Zwarts J (eds) *Weak Referentiality. Linguistik Aktuell/Linguistics Today* 219, pp 213–135
- Seidel E (2019) Anaphoric potential of bare nouns and event structure in Turkish. PhD thesis, University of Cologne
- Sezer A (1996) Türkçe’de Sözdizimsel Kısıtlamalar. In: IX. Dilbilim Kurultayı Bildirileri, pp 236–263
- Speas M (1990) *Phrase structure in natural language*. Kluwer, Dordrecht
- Taylan E (1984) *The Function of Word Order in Turkish Grammar*. University of California Press, Berkeley, California
- Taylan EE, Öztürk B (2014) Transitivity in pazar laz. *Acta Linguistica Hungarica* 61(3):271–296, URL <http://www.jstor.org/stable/26191758>
- Vergnaud JR (2008) Letter to noam chomsky and howard lasnik on "filters and control,"" april 17, 1977. In: *Foundational Issues in Linguistic Theory: Essays in Honor of Jean-Roger Vergnaud*, The MIT Press, DOI 10.7551/mitpress/7713.003.0004
- Woolford E (2015) Ergativity and Transitivity. *Linguistic Inquiry* 46(3):489–531
- Yip M, Maling J, Jackendoff R (1987) Case in tiers. *Language* 63(2):217–250